

# Experimental study on optimizing cheese drying and ripening process

F. Giametta, E. Sorrentino, A. Lapenna, G. La Fianza\*

(Department. S.A.V.A., Faculty of Agriculture, University of Molise, Via De Sanctis, 86100, Campobasso, Italy)

**Abstract:** The system proposed in this paper consists of humidity and temperature control during the food maturation process by using a dehumidifier equipped with a desiccant rotor containing silica gel. In this system the condensation/drainage stage is omitted since the humid room air is directed out of the cold store (process air) and the dried air is introduced via the dehumidifier inside the cold store. It allows separate control of the humidity and temperature inside the cold store. The experimental results are obtained in real conditions; the weight loss of the products was determined and it was, also, proved that dried products such as cheeses treated by this method retain their fresh color, texture and other organoleptic properties to ensure their final quality.

**Keywords:** air velocity, cheese, drying, ripening, water loss, relative humidity (RH)

**DOI:** 10.3965/j.ijabe.20120504.009

**Citation:** Giametta F, Sorrentino E, Lapenna A, La Fianza G. Experimental study on optimizing cheese drying and ripening process. Int J Agric & Biol Eng, 2012; 5(4): 74–82.

## 1 Introduction

Drying and maturation processes are commonly used in food production, but a thorough scientific approach has not been so widely applied. Empiric rules are often used to set up industrial production, particularly in small-medium firms. Humidity control of food is achieved by regulation of the relative humidity (RH) and room temperature, taking into account the water evaporation inside the food matrix according to the air velocity<sup>[1,2]</sup>. In the ripening or drying processes, an important loss of water occurred. In fact, water is vaporized from the wet surface to the air stream and, in general, this transfer is evaluated by using a global mass transfer coefficient. Moreover, during water removal

from the surface, it diffuses from the interior of the solid towards the surface<sup>[3]</sup>. Diffusivity controls the movement of water to the food surface and the development of internal moisture profiles. The superficial water activity is determined by the balance between water evaporation and the internal movement of water to the surface<sup>[4]</sup>; therefore the knowledge of the moisture distribution inside the product during ripening is very important for the control of the process. The overall water transfer is influenced by the internal water migration<sup>[5]</sup>; anyway, some conditions as low air velocity and high humidity of the drying medium, determine a low drying rate and mass flux within the product. In these cases, external resistance to mass transfer becomes important and must be considered<sup>[6-9]</sup>. The system proposed in this paper consists of humidity and temperature control during the food (cheese) ripening process by using a system equipped with an absorbing dehumidifier rotor. It allows separate control of the humidity and temperature inside the cold store<sup>[2,10-12]</sup>. This system can be used for other foodstuffs with different humidity requirements; it can also be used for storing stocks of perspiring food such as fruit and vegetables<sup>[13,14]</sup>. Many efforts have been carried out to

**Received date:** 2012-03-17 **Accepted date:** 2012-09-12

**Biographies:** **F. Giametta**, Associate Professor of Mechanical Engineering. Tel: +39(0874) 4041, Fax: +39(0874)404855; Email: f.giametta@unimol.it. **E. Sorrentino**, Associate Professor of Microbiology. Tel: +39(0874) 4041, Fax: +39(0874)404855; Email: sorrentino@unimol.it. **A. Lapenna**, Graduate student in Food Engineering. Email: lapennaibero.it.

\***Corresponding author:** **G. La Fianza**, Associate Professor of Technical Physics. Tel: +39(0874) 4041, Fax: +39(0874)404855; Email: lafianza@unimol.it.

reduce costs in most of such kind of processes. In drying and ripening processes, which induce water transfer and weight loss, the knowledge of the mass transfer mechanisms permits not only to reduce the operation costs but also to improve the quality of the final product<sup>[15-17]</sup>. The cheese employed in this study is Scamorza, a *pasta filata* cheese produced in South Italy. It is obtained from pasteurized cow milk and has a pear-like shape with a prominent and distinct “head” on the tip, which is formed by the rope that is used to hang the cheese during drying process. Scamorza has a slight yellow colour, compact texture, about 200 g weights and could be commercialized after one day of drying or after other 15-20 days of ripening.

The aim of this study was to give a contribution to the numerous activities of research focusing on the study of the optimization of the plan parameters and of the drying system as in fact the experimental results are obtained in real conditions. Moreover, this study is a preliminary test to see if the position in the ripening room can influence the final quality of cheese.

## 2 Materials and methods

### 2.1 Drying system

Experimental tests were carried out on the drying system which consists of a cold store (Figures 1 and 2), containing a dehumidifier (Figure 3) which controls the humidity of the room air. In this system the condensation/drainage stage is omitted since the humid room air is directed out of the cold store (process air) and the dried air is introduced by the dehumidifier inside the cold store.

The refrigeration system prevents any rise in temperature. In this case, the temperature of the cold battery is maintained at a level higher than the dew point to avoid vapour condensation and anomalous behaviours of the RH of the room. In this system the temperature and RH are controlled independently leading to significant benefits. In fact, this system positively affects the amount of electrical energy consumed during the refrigeration process because less power is required and the system is actively working for a shorter period than a traditional refrigeration system<sup>[10,11]</sup>.

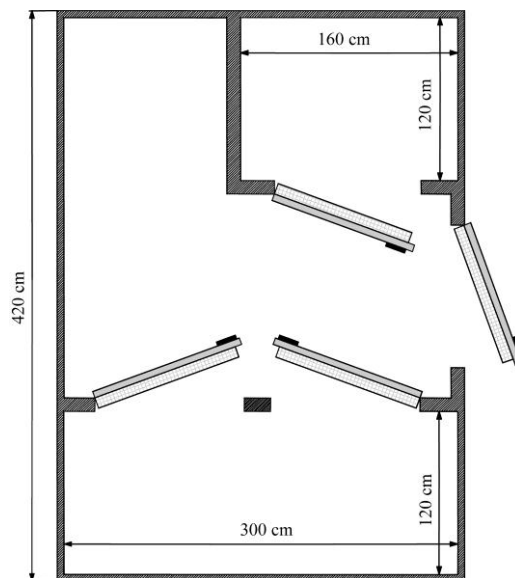

Figure 1 Cell plant

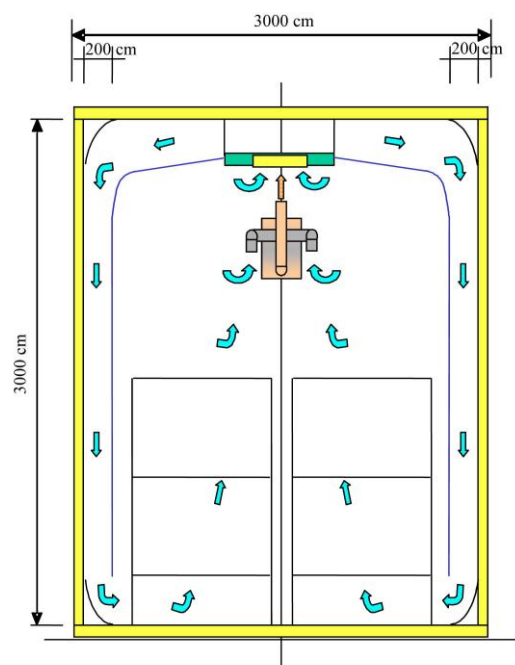

Figure 2 Air flow in the cell

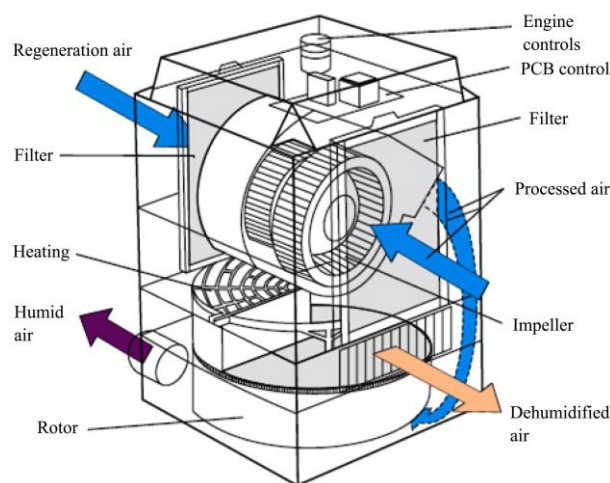

Figure 3 Dehumidifier with the rotor containing silica gel

## 2.2 Cheese samples

Scamorza cheeses produced in small dairy industry ("Caseificio Molisano L. Barone s.n.c.", Vinchiaturò, CB, Italy) after production were immediately stored at 4°C and delivered to the cold store of the laboratory within one hour. The Scamorza samples were divided into five batches. Three batches were hanging on the lateral undercarriage and two batches on the central undercarriage. For the samples of the lateral undercarriage, they are marked as Lateral high (LA), Lateral center (LC), and Lateral low (LB). For the samples of the central undercarriage, they are marked as Central high (CA) and Central low (CB).

The disposition on the lateral undercarriage and the identification nomenclature were 1) First sample, LA; 2) Second sample, LC; 3) Third sample, LB. For the central undercarriage, they were: 4) Fourth sample, CA; 5) Fifth sample, CB.

## 2.3 Process parameters

The following process parameters were fixed before starting up the drying system:

1) the daily loss of weight both as a percentage and as the absolute value relative to the intake load of the cold store;

2) the daily dehumidification cycles (a dehumidification cycle is composed of an active period and a pause period of the dehumidifier);

3) the dehumidifier capacity during the pause and process cycles;

4) the length of the dehumidification period which must be planned for every cycle.

These parameters must be fixed in order to obtain a product of high quality.

In order to find the temperatures in the cold store, eight silver-plated copper probes, model DLE090 with sensing element Pt100, produced from the LSI Lastem were used. The maximum noticeable temperature with aforesaid probes is 80°C. The compact probe HOBO U12-012 was used to measure the RH and temperature in the same place. In order to evaluate the product weight loss and its trend during the test, periodic weighing of some samples was performed. A hot wire anemometer was used to measure the absolute speed of the air inside

the cold store, connected to a data logger BABUC A to analyze the behaviour of the cell from the thermal and fluid dynamic point of view.

The drying tests of products (Figure 4) were carried out with two different regulations of temperature and RH: 1)  $T_{\min} = 12.0^{\circ}\text{C}$ ,  $T_{\max} = 13.0^{\circ}\text{C}$ ,  $RH_{\max} = 70\%$ , duration: 16 hours; 2)  $T_{\min} = 9.5^{\circ}\text{C}$ ,  $T_{\max} = 11.5^{\circ}\text{C}$ ,  $RH_{\max} = 90\%$ , duration: 28 hours.



Figure 4 Undercarriage with cheeses

The test was carried out in spring. It was repeated four times not only to confirm the results but also to change the position of the probes inside the cell and have more data regarding temperatures and humidity trend for the simulation.

Usually the Scamorza undergoes a dehydration phase which lasts from 24 hours to 48 hours. In our case it was stopped in 44 hours because the products had reached a constant weight.

## 2.4 The first test

### 2.4.1 First ripening phase

In the first ripening phase, to which corresponds the first test lasted for 16 hours, a minimal RH of 65% and a maximum RH of 70%,  $T_{\min}$  of 12°C and a  $T_{\max}$  of 13°C were set up. The temperature probes, numbered from 1 to 8, were positioned as shown in Figure 5, while the anemometer was positioned in the middle of the cell, at a height of 115 cm from the floor (Figure 6). A Hobo sensor was placed on the floor of the cell, and in the middle of the central undercarriage (Figure 7). At the end of the first 16 hours period the samples were weighed.

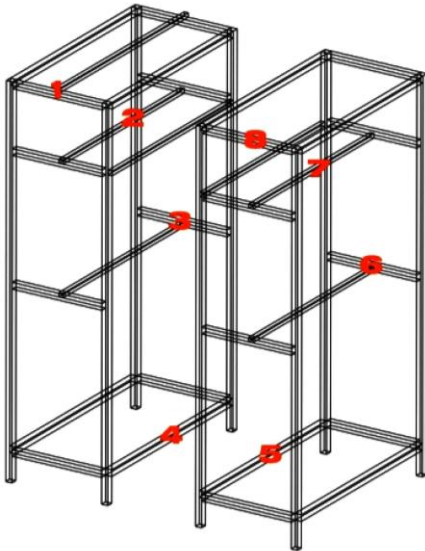

Figure 5 Temperature probes positions

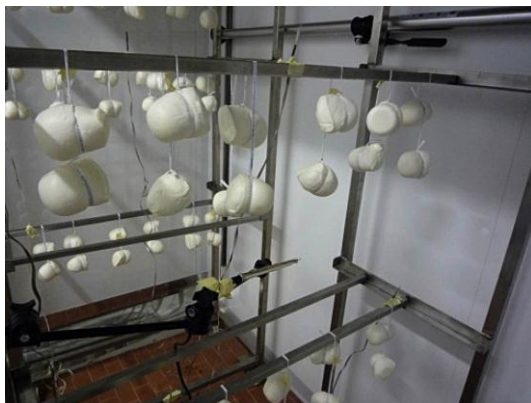

Figure 6 Anemometer (115 cm from floor)



Figure 7 Hobo position

#### 2.4.2 Second ripening phase

In the second ripening phase, to which correspond the second, the third and the fourth tests, a minimal RH of 85%, a maximum RH of 90% and a temperature range from a  $T_{\min}$  of 9.5°C to a  $T_{\max}$  of 11.5°C were set up, for a

total duration of the trials of 28 hours.

#### 2.5 The second test

For the second test, the temperature probes were placed as shown in Figure 8 and the anemometer was placed to a height of 23 cm from the floor (Figure 9). A first Hobo sensor was positioned in correspondence of the sample, CB (Figure 10); the second one in correspondence of the Munters dehumidifier.

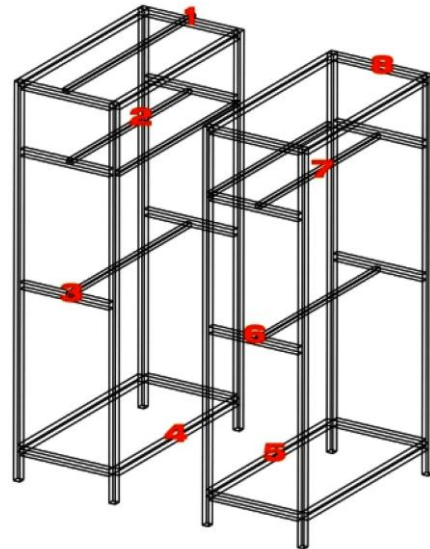

Figure 8 Temperature probes positions



Figure 9 Anemometer (central, 23 cm from floor)



Figure 10 Hobo position

**2.6 The third test**

During the third test, the Hobo and the temperature probes did not change their positions (Figure 11). The only variation occurred in the location of the anemometer that was positioned at a distance of 50 cm from the lateral panel (Figure 12).

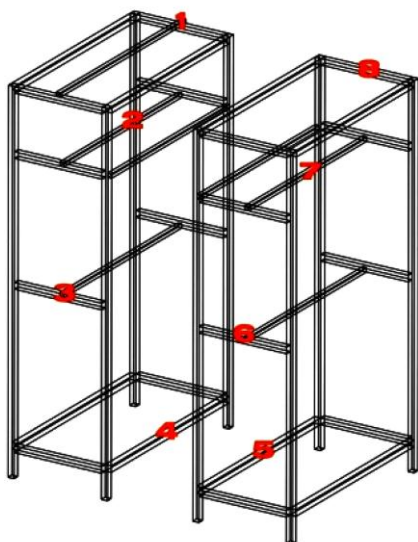

Figure 11 Temperature probes positions



Figure 12 Anemometer (50 cm from lateral panel; 23 cm from floor)

**2.7 The fourth test**

The temperature probes were placed, except for the No. 4 (the same position for all the tests), on the lateral panels and on the frontal wall of the cell (Figure 13). Probes 2 and 5 were fixed on the left lateral panel and on the right lateral panel, respectively, at a height of 130 cm, centrally, at a distance of 60 cm from the front wall.

In the fourth and last tests, the Hobos were positioned in correspondence of the lateral undercarriage: the first one on the floor and the second one lined up with the lateral sample “low”. The anemometer was positioned

at a distance of 5 cm from the lateral panel (Figure 14).

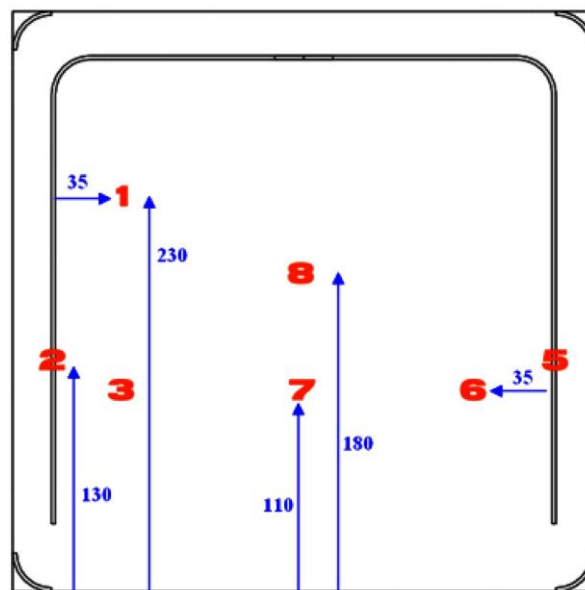

Figure 13 Temperature probes positions



Figure 14 Hobo positions

**2.8 Analysis of the cheeses**

The weight loss of cheese was periodically evaluated on 10 samples of each batch using an electronic balance (AND GF-1200-EC, precision 0.01 g).

Colour was determined on the surface of Scamorza using the Hunter L\*, a\*, b\* system with a reflectance spectrophotometer (Minolta CR300b, Suita-shi, Osaka, Japan). The results were expressed as the mean of three determinations performed on different parts of six samples for each batch.

An untrained panel (12 judges) assessed the sensory properties of the Scamorza. The characteristics evaluated were inner aspect, outer aspect and flavour. The cheese samples were served at room temperature.

### 3 Results and discussion

The daily weight loss is related to the number of cycles and to the dehumidification capacity, giving the process-time of the dehumidifier<sup>[18-20]</sup>. Another parameter which has an influence on the drying process of cheese is the geometry of the product: such kind of product has a good surface/volume ratio thus facilitating the drying procedure<sup>[21]</sup>.

The correct management of this parameter (the geometry of the product) will result in an optimal quality and a uniform loss of weight in the product. As seen in Figure 15, the samples which showed the greater weight loss were CA and CB. This result already had been assumed as in the central part of the cell, the greater turbulence of the air occurs determining a higher loss of water from the products. The trend of the weight loss is shown in Figure 16.

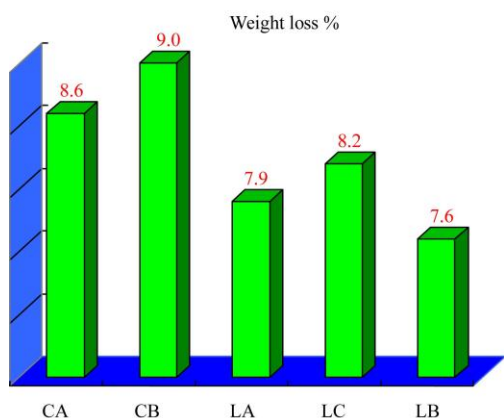

Figure 15 Weight loss for each sample

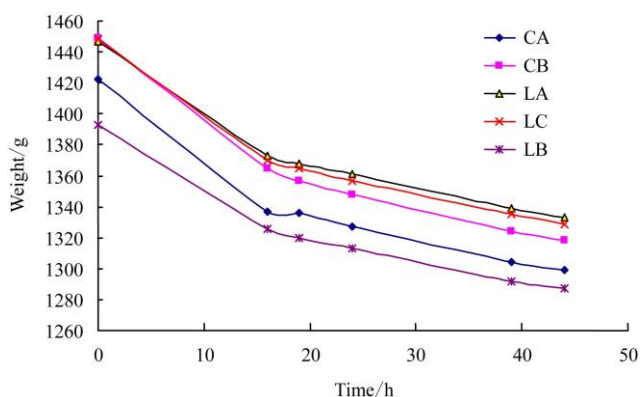

Figure 16 Trend of weight loss

The colorimetric indices showed an increase of the index of yellow (*b*) during the ripening of the Scamorza cheeses that at time 0 was 16.59. However, a substantial difference in colour was noticeable between central and lateral batches. In detail, after 44 hours of ripening, the batches L had a higher intensity of yellow (*b* = 21.30) compared to the batches C (*b* = 19.57). This result is very interesting if we consider that this index is of particular importance in driving consumer choice.

The sensory analysis has shown a preference of the judges for the cheeses of batches L, especially as regards outer aspect and flavour (data not shown).

In the first test ( $T_{min} = 12^{\circ}C$  and  $T_{max} = 13^{\circ}C$ ), some medium values slightly under the minimal settled value were logged (Table 1). In the second and the third test, the medium values of temperature, remaining in the set up interval, were considered as acceptable (Table 1). In the fourth test (probes on the frontal walls), the values were logged by probes 2 and 5, located on the left and on the right lateral panel, respectively. These turn out to be the colder surfaces as constantly licked from the air coming from the cold battery. The temperature is slightly higher (for probe 8,  $T = 10.7^{\circ}C$ ), considering the frontal wall of the cell (Table 1).

Table 1 Probe mean temperatures ( $^{\circ}C$ ) for all tests

Probe	Test I	Test II	Test III	Test IV
1	11.0	10.0	9.9	11.2
2	11.3	9.6	9.5	9.5
3	11.8	10.0	9.8	10.0
4	11.6	10.4	10.5	10.4
5	11.4	10.0	9.9	9.8
6	11.8	10.0	9.8	10.2
7	11.6	10.0	9.9	10.0
8	11.4	10.4	10.2	10.7

The experimental results, concerning the measure of the RH occurring in the cell during the tests and logged by the Hobo sensor, are shown in Figures 17-20.

The medium RH logged by the Hobo has turned out to be lower respect to the minimal RH set up by the control panel. It depends on the fact that the dehumidification starts at the beginning of the working cycle and is not due to the overcoming of the maximum RH. Therefore, the RH is checked by time and by the

minimal RH reached. The mean velocity and the standard deviation were also calculated by the data logged by the anemometer during each test. The results are shown in Table 2, where  $h$  is the height of the anemometer from the floor and  $d$  is the distance from the left lateral panel.

It turns out as the central zone of the cell, whereby the anemometer has been located to a height of 23 cm from the ground, shows a zone of easy development of high

turbulence as located underneath and perpendicularly the coming air flowing from the dehumidifier.

**Table 2 Velocity and standard deviation related to the anemometer position**

Anemometer position	Mean velocity /m s <sup>-1</sup>	Standard deviation /m s <sup>-1</sup>
Cell center ( $h = 115$ cm)	0.06	0.06
Cell center ( $h = 23$ cm)	0.21	0.14
Lateral ( $d = 50$ cm, $h = 23$ cm)	0.13	0.09
Lateral ( $d = 5$ cm, $h = 23$ cm)	0.15	0.13

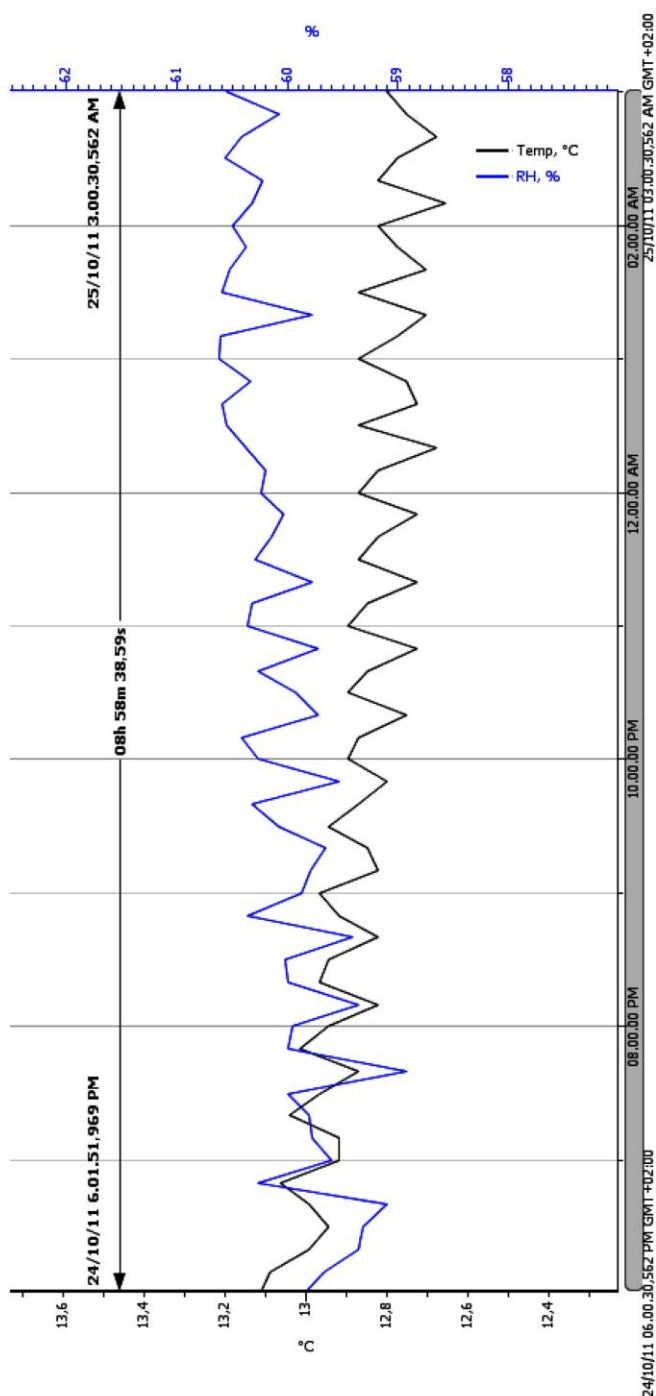

Figure 17 Temperature and RH in Hobo low center cell during test I

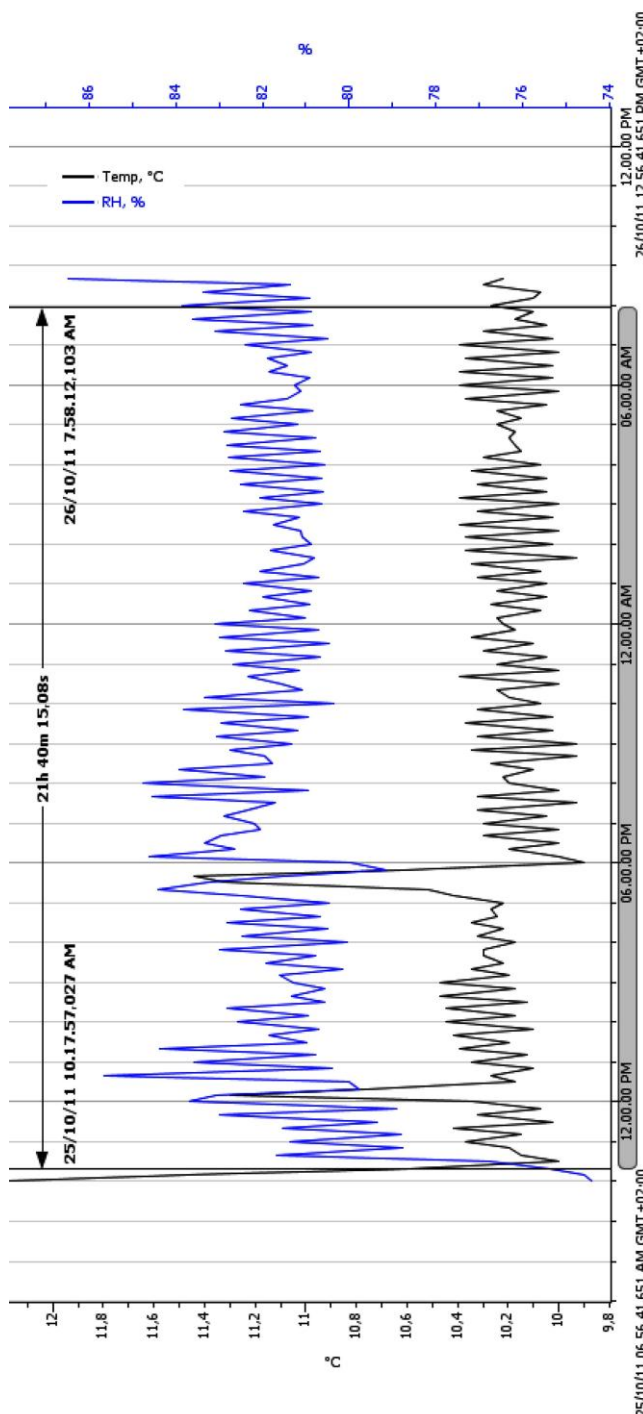

Figure 18 Temperature and RH in Hobo middle central undercarriage during test II

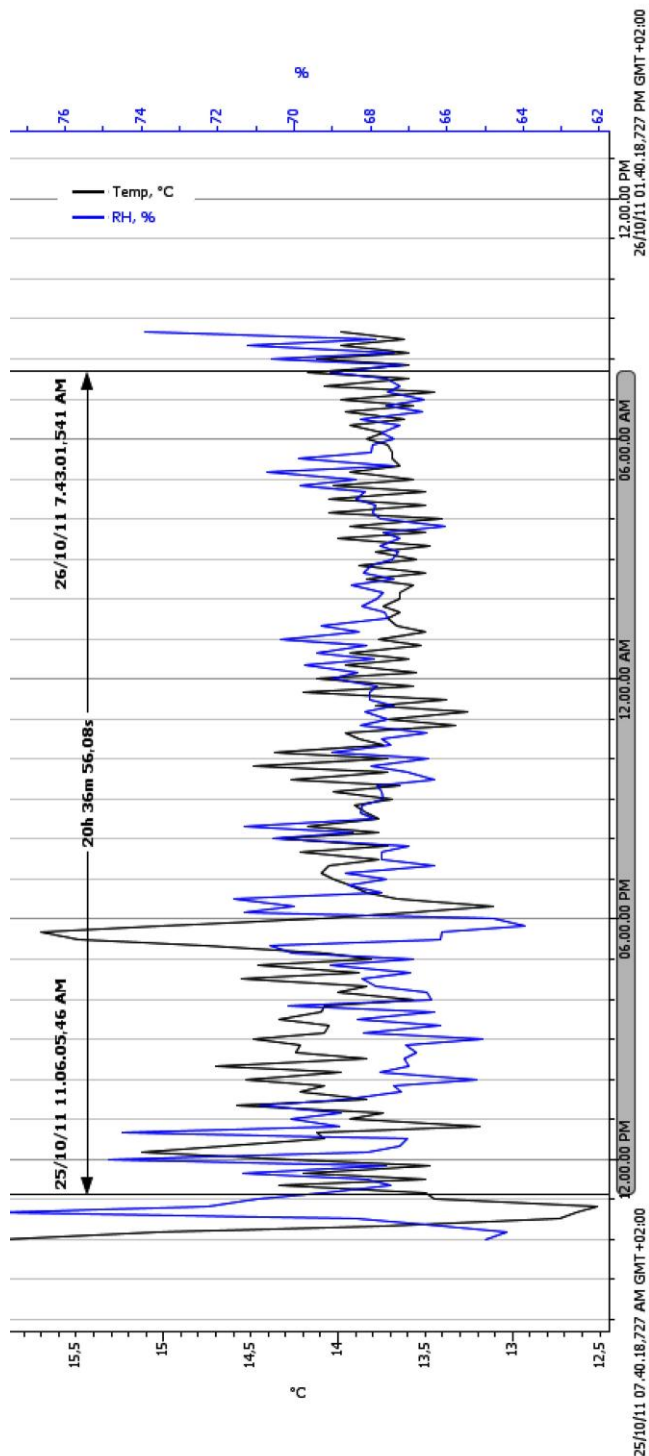

Figure 19 Temperature and RH in Hobo near Munters during test III

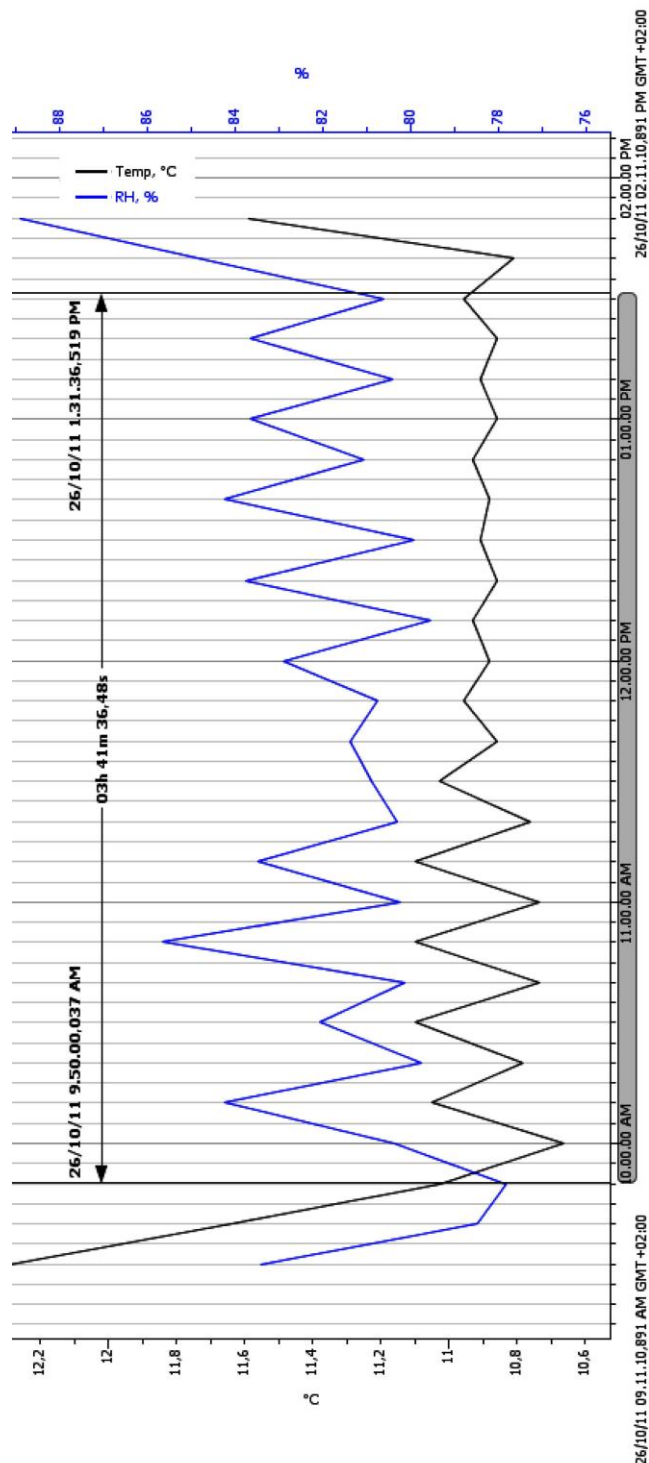

Figure 20 Temperature and RH in Hobo low lateral during test IV

### 4 Conclusions

The aim of this study was to give a contribution to the numerous activities of research turned to study the optimization of the plan parameters and of the drying system working. In particular, the application of such typologies of systems to the process of cheese ripening to

spin paste is finalized to obtain some products of quality from the organoleptic, sensory and hygienic point of view. A dehumidification-absorption system can constitute, in fact, an optimal system of ripening; It can better understand the reliability and the duration in the time of the system refrigerator, of the probes of the dehumidifier and the system of supervision. In our case, the duration



of the drying test has been altogether of 44 hours but varying the formulation of the temperature and RH parameters, probably the drying process can be accelerated with a consequent saving of time and energy. The objective of a future activity of research in such a field is the optimization of the system and the duration of the cycle of ripening of the product, in the optical of an always greater energy saving, of a lesser wear and tear of the system, of reduced time of working and a result in compliance with the organoleptic and trading standards.

### [References]

- [1] May B K, Perr èP. The importance of considering exchange surface area reduction to exhibit a constant drying flux period in foodstuffs. *Journal of Food Engineering*, 2002; 54: 271-282.
- [2] Dias S, Futata F P L, Garvalho J A, Couto S, Ferreira M A. Investigation of food drain drying with pulsating air flows. *International Communications in Heat and Mass Transfer*, 2004; 31(3): 387-395.
- [3] McMinn W A M, Magee T R A. Principles, methods and applications of the convective drying of foodstuffs. *Food and Bioproducts Processing*, 1999; 77(3): 175-193.
- [4] Trujillo F J, Wiangkaew C, Pham Q I. Drying modelling and water diffusivity in beef meat. *Journal of Food Engineering*, 2007; 78(1): 74-85.
- [5] Frias J M, Foucat L, Bimbenet J J, Bonazzi C. Modelling of moisture profiles in paddy rice during drying mapped with magnetic resonance imaging. *Chemical Engineering Journal*, 2002; 86(1-2): 173-178.
- [6] Carcel J A, Garcia-Perez J V, Riera E, Mulet A. Influence of high-intensity ultrasound on drying kinetics of persimmon. *Drying Technology*, 2007; 25(1): 185-193.
- [7] Clemente G, Bon J, Garcia-Perez J V, Mulet A. Natural convection drying at low temperature of previously frozen salted meat. *Drying Technology*, 2007; 25(11): 1885-1891.
- [8] Markowski M. Air drying of vegetables: evaluation of mass transfer coefficient. *Journal of Food Engineering*, 1997; 34(1): 55-62.
- [9] Riahi M H, Trelea I C, Leclercq-Perlat M N, Piacque D, Corrieu G. Model for changes in weight and dry matter during the ripening of a smear soft cheese under controlled temperature and relative humidity. *International Dairy Journal*, 2007; 17(8): 946-953.
- [10] Nogaya K, Li Y, Jin Z, Fukumuro M, Ando Y, Akaishi A. Low temperature desiccant-based food drying system. *Journal of Food Engineering*, 2006; 75: 71-77.
- [11] Brunetti L, Fucci F, La Fianza G. Un impianto di stagionatura a deumidificazione per assorbimento per alimenti. *La Termotecnica*, 2004; Anno LVII, 4: 68-71.
- [12] Salsilmaz C, Yildiz C, Pehlivan D. Drying of apricots in a rotary column cylindrical dryer (RCCD) supported with solar energy. *Renewable Energy*, 2000; 21(2): 117-127.
- [13] Pasini A. Asciugamento delle carni insaccate, *Il Freddo*, 1999, 53: 47.
- [14] Vega-Mercado P, G óngora-Nieto M, Barbosa-C ánovas G V. Advances in dehydration foods. *Journal of Food Engineering*, 2001; 49: 271-281.
- [15] Bon J, Rossell ò C, Femenia A, Eim V, Simal S. Mathematical modeling of drying kinetics for apricots: influence of the external resistance to mass transfer. *Drying Technology*, 2007; 25(11): 1829-1835.
- [16] Hernandez-Perez J A, Garcia-Alvarado M A, Trystram G, Heyd B. Neural networks for the heat and mass transfer prediction durino drying of cassava and mango. *Innovative Food Science and Emerging Technologies*, 2004; 5(1): 57-64.
- [17] Lertworasirikul S, Saetan S. Artificial neural network modeling of mass transfer durino osmotic dehydration of kaffir lime peel. *Journal of Food Engineering*, 2010; 98(2): 214-223.
- [18] Gac A. Equipements frigoriferiques: automatisme et conception. *Lavoisier Tec & Doc*, 1997.
- [19] Fiameni C, Esposti V. Celle frigorifere. *Il Freddo*, 2000, 54: 646.
- [20] Ho J C, Chou S K, Chua K J, Mujumdar A S, Hawlader M N A. Analytical study of cyclic temperature drying: effects on drying kinetics and product quality. *Journal of Food Engineering*, 2002; 51(1): 65-75.
- [21] Taraschi N. Il freddo e la conservazione degli alimenti. Principi teorici. *Il Freddo*, 2000; 54: 62.
- [22] Cengel AY. Introduction to thermodynamics and heat transfer. *Mc Graw Hill Ed.* 1997.