

Jatropha oil methyl ester and its blends used as an alternative fuel in diesel engine

Y. V. Hanumantha Rao¹, Ram Sudheer Voleti¹,
V. S. Hariharan², A. V. Sitarama Raju³

(1. Department of Mechanical Engineering, Koneru Lakshmaiah College of Engineering, Green Fields, Guntur-522502, Andhra Pradesh, India; 2. Department of Mechanical Engineering, Lakireddy Balireddy College of Engineering, Mylavaram, Krishna Dt, Andhra Pradesh, India; 3. Department of Mechanical Engineering, Jawaharlal Nehru Technological University College of Engineering, Kakinada, Pin: 533003, Andhra Pradesh, India)

Abstract: Biomass derived vegetable oils are quite promising alternative fuels for agricultural diesel engines. Use of vegetable oils in diesel engines leads to slightly inferior performance and higher smoke emissions due to their high viscosity. The performance of vegetable oils can be improved by modifying them through the transesterification process. In this present work, the performance of single cylinder water-cooled diesel engine using methyl-ester of Jatropha oil as the fuel was evaluated for its performance and exhaust emissions. The fuel properties of biodiesel such as kinematic viscosity, calorific value, flash point, carbon residue and specific gravity were found. Results indicate that B25 has closer performance to diesel and B100 has lower brake thermal efficiency mainly due to its high viscosity compared to diesel. The brake thermal efficiency for biodiesel and its blends was found to be slightly higher than that of diesel fuel at tested load conditions and there was no difference of efficiency between the biodiesel and its blended fuels. For Jatropha biodiesel and its blended fuels, the exhaust gas temperature increased with the increase of power and amount of biodiesel. However, its diesel blends showed reasonable efficiencies, lower smoke, CO₂, CO and HC emissions.

Keywords: Jatropha oil, bio-fuels, transesterification, performance and emission characteristics

DOI: 10.3965/j.issn.1934-6344.2008.02.032-038

Citation: Hanumantha Rao Y V, Ram Sudheer Voleti, Hariharan V S, Sitarama Raju A V. Jatropha oil methyl ester and its blends used as an alternative fuel in diesel engine. Int J Agric & Biol Eng. 2008; 1(2): 32–38.

1 Introduction

Diesel engines are the most efficient prime movers. From the point of view of protecting global environment and concerns for long-term energy security, it becomes

necessary to develop alternative fuels with properties comparable to petroleum based fuels. Unlike the rest of the world, India's demand for diesel fuels is roughly six times that of gasoline, hence seeking alternative to mineral diesel is a natural choice^[1,2]. The rapid depletion of petroleum reserves and rising oil prices has led to the search for alternative fuels. Non edible oils are promising fuels for agricultural applications. Vegetable oils have properties comparable to diesel and can be used to run CI engines with little or no modifications. Usage of biodiesel will allow a balance to be sought between agriculture, economic development and the environment^[3,4].

Jatropha curcas is non-edible oil being singled out for large-scale plantation on wastelands. Jatropha curcas plant can thrive under adverse conditions. It is a drought-resistant, perennial plant, living up to fifty years and has capability to grow on marginal soils. It requires very little irrigation and grows in all types of soils (from coastline to hill slopes). The production of Jatropha seeds is about 0.8 kg per square meter per year. The oil content of Jatropha seed ranges from 30% to 40% by

Received date: 2008-10-24 Accepted date: 2008-12-01

Biographies: **Y. V. Hanumantha Rao**, Assistant Prof, Department of Mechanical Engineering, Koneru Lakshmaiah College of Engineering, Green Fields, Guntur-522502, Fax: +918645-247249, Andhra Pradesh, India. Email: rao_yvh@yahoo.co.in. **Ram Sudheer Voleti**, Graduating Student, Department of Mechanical Engineering, Koneru Lakshmaiah College of Engineering, Guntur-522502, Fax: +918645-247249, Andhra Pradesh, India. Email: mechanicalmighty@yahoo.co.in. **V. S. Hariharan**, Associate Prof, Department of Mechanical Engineering, Lakireddy Balireddy College of Engineering, Mylavaram, Krishna Dt, Fax: +918659-222931, Andhra Pradesh, India. Email: hariharan_vs@rediffmail.com. **A. V. Sitarama Raju**, Professor, Department of Mechanical Engineering, Jawaharlal Nehru Technological University College of Engineering, Kakinada, Pin: 533003, Andhra Pradesh, India.

Corresponding author: **Ram Sudheer Voleti**, Department of Mechanical Engineering, Koneru Lakshmaiah College of Engineering, Guntur-522502, Fax: +918645-247249, Andhra Pradesh, India. Email: mechanicalmighty@yahoo.co.in

weight and the kernel itself ranges from 45% to 60%. Fresh Jatropha oil is slow-drying, odorless and colorless oil, but it turns yellow after aging^[5]. In Madagascar, Cape Verde and Benin, Jatropha oil was used as mineral diesel substitute during the Second World War. Forson et al. used Jatropha oil and diesel blends in CI engines and found its performance and emissions characteristics similar to that of mineral diesel at low concentration of Jatropha oil in blends^[6]. Pramanik tried to reduce viscosity of Jatropha oil by heating it and also blending it with mineral diesel^[7].

The objective of the present research was to explore technical feasibility of Jatropha oil in direct injection compression ignition engine without any substantial hardware modifications. In this work the methyl ester of Jatropha oil was investigated for its performance as a diesel engine fuel. Fuel properties of mineral diesel, Jatropha biodiesel and Jatropha oil were evaluated. Three blends were obtained by mixing diesel and esterified Jatropha in the following proportions by volume: 75% Diesel+25% Esterified Jatropha, 50% Diesel+50% Esterified Jatropha and 25% Diesel+75% Esterified Jatropha. Performance parameters like brake thermal efficiency, specific fuel consumption, brake power were determined. Exhaust emissions like CO₂, CO, NO_x and smoke have been evaluated. For comparison purposes experiments were also carried out on 100% esterified Jatropha and diesel fuel.

2 Materials and methods

A lot of research work has been carried out to use vegetable oil both in its neat form and modified form^[2,5-7,9-18]. Studies have shown that the usage of vegetable oils in neat form is possible but not preferable^[3]. The high viscosity of vegetable oils and the low volatility affect the atomization and spray pattern of fuel, leading to incomplete combustion and severe carbon deposits, injector choking and piston ring sticking. The methods used to reduce the viscosity are

- * Blending with diesel
- * Emulsification
- * Pyrolysis
- * Transesterification

Among these, the transesterification is the commonly used commercial process to produce clean and environmental friendly fuel^[7,9]. However, this adds extra cost of processing because of the transesterification reaction involving chemical and process heat inputs.

2.1 Materials and transesterification process

The conversion of Jatropha oil into its methyl ester

can be accomplished by the transesterification process. Transesterification involves reaction of the triglycerides of Jatropha oil with methyl alcohol in the presence of a catalyst Sodium Hydroxide (NaOH) to produce glycerol and fatty acid ester.

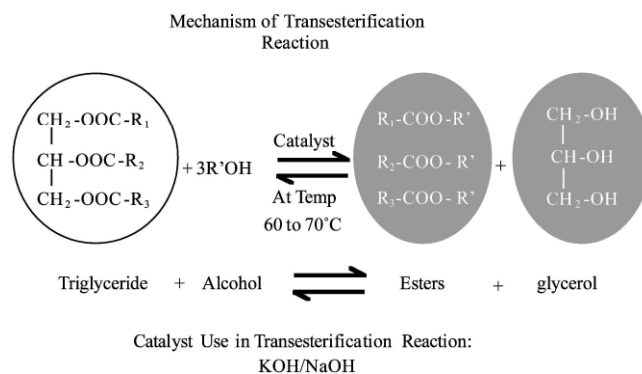

Figure 1 Diagram showing the mechanism of transesterification reaction

The production of biodiesel by transesterification of the oil generally occurs using the following steps:

1) *Mixing of alcohol and catalyst.* For this process, a specified amount of 450mL methanol and 10g Sodium Hydroxide (NaOH) was mixed in a round bottom flask.

2) *Reaction.* The alcohol/catalyst mixture was then charged into a closed reaction vessel and 1000 mL Jatropha oil was added. Excess alcohol was normally used to ensure the total conversion of the fat or oil to its esters.

3) *Separation of glycerin and biodiesel.* Once the reaction is complete, two major products exist: glycerin and biodiesel. The quantity of produced glycerin varies according the oil used, the process used, the amount of excess alcohol used. Both the glycerin and biodiesel products had a substantial amount of the excess alcohol that was used in the reaction. The reacted mixture is sometimes neutralized at this step if needed.

4) *Alcohol Removal.*

5) *Glycerin Neutralization.* The glycerin by-product contains unused catalyst and soaps that are neutralized with an acid and sent to storage as crude glycerin. In some cases the salt formed during this phase is recovered for use as fertilizer. In most cases the salt is left in the glycerin.

6) *Methyl Ester Wash.* The most important aspects of biodiesel production to ensure trouble free operation in diesel engines are complete reaction, removal of glycerin, removal of catalyst, removal of alcohol and absence of free fatty acids.

2.2 Experimental setup

The engine used for this experimental investigation

was a single cylinder 4-stroke naturally aspirated water cooled diesel engine having 5 BHP as rated power at 1500 r/min. The engine was coupled to a brake drum dynamometer to measure the output. Fuel flow rates were timed with calibrated burette. Exhaust gas analysis was performed using a multi gas exhaust analyzer. The pressure crank angle diagram was obtained with the help of a piezo electric pressure transducer. A Bosch smoke pump attached to the exhaust pipe was used for measuring smoke levels. The total experimental set up is shown in Figure 2.

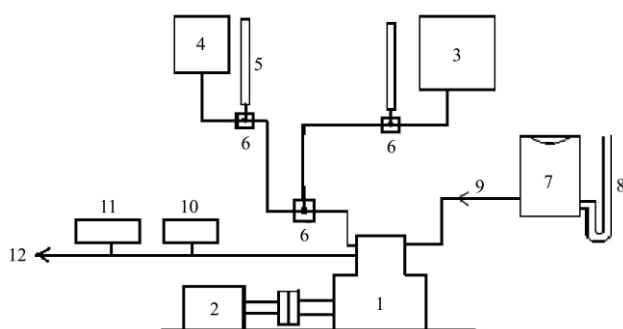

1. Engine 2. Brake drum dynamometer 3. Fuel tank (biodiesel) 4. Diesel tank 5. Burettes 6. Three-way valve 7. Air box 8. Manometer 9. Air flow direction 10. Exhaust Analyzer 11. Smoke meter 12. Exhaust flow

Figure 2 Experimental setup

The technical specifications of diesel engine are given below.

Manufacturer:	Kirloskar engines Ltd, Pune, India
No of cylinders:	One
No. of strokes:	Four
Bore & Stroke:	80 & 110 mm
Capacity:	3.68 kW
BHP of engine:	5
Speed:	1500 r/min
Mode of injection:	DI
Cooling system:	Water

2.3 Experimental procedure

Experiments were initially carried out on the engine using diesel as the fuel in order to provide base line data^[8]. The cooling water temperature at the outlet was maintained at 70°C. The engine was stabilized before taking all measurements. Subsequently experiments were repeated with methyl ester of Jatropha oil for comparison. In all cases the pressure and crank angle diagram was recorded and processed to get combustion parameters.

3 Results and discussion

The fuels (Mineral diesel, Jatropha Biodiesel and Jatropha oil) were analyzed for several physical, chemical

and thermal properties and results are listed in Table 1.

Density, cloud point and pour point of Jatropha oil were found higher than those of diesel. Higher cloud and pour point reflect unsuitability of Jatropha oil as diesel fuel in cold climatic conditions. The flash and fire points of Jatropha oil were quite high compared to diesel. Hence, Jatropha oil is extremely safe to handle^[10,11]. Higher carbon residue from Jatropha oil may possibly lead to higher carbon deposits in combustion chamber of the engine. Low sulphur content in Jatropha oil results in lower SO_x emissions. Presence of oxygen in fuel improves combustion properties and emissions but reduces the calorific value of the fuel^[12,13]. Jatropha oil has approximately 90% calorific value compared to diesel. Nitrogen content of the fuel also affects the NO_x emissions.

Table 1 Fuel properties of mineral diesel, Jatropha biodiesel, Jatropha oil

Sl.No	Property	Mineral diesel	Jatropha biodiesel	Jatropha oil
1.	Density(kg/m ³)	840±1.732	879	917±1
2.	Kinematic Viscosity at 40°C(cst)	2.44±0.27	4.84	35.98±1.3
3.	Pour Point (°C)	6±1	3±1	4±1
4.	Flash Point (°C)	71±3	191	229±4
5.	Conradson Carbon Residue (% w/w)	0.1±0.0	0.01	0.8±0.1
6.	Ash Content (% w/w)	0.01±0.0	0.013	0.03±0.0
7.	Calorific Value (MJ/kg)	45.343	38.5	39.071
8.	Sulphur (% w/w)	0.25	<0.001	0
9.	Cetane No.	48-56	51-52	23-41
10.	Carbon (% w/w)	86.83	77.1	76.11
11.	Hydrogen (% w/w)	12.72	11.81	10.52
12.	Oxygen (% w/w)	1.19	10.97	11.06

Higher viscosity is a major problem in using vegetable oil as fuel for diesel engines. In the present investigation viscosity was reduced by transesterification process. Viscosity of Jatropha biodiesel is 4.84 cst at 40°C. It is observed that viscosity of Jatropha oil decreases remarkably with increasing temperature and it becomes close to diesel at temperature above 90°C.

3.1 Experimental data

The experimental data included the combustion parameters like Fuel Consumption (F.C), Specific Fuel Consumption (S.F.C), Brake Power (B.P), Brake Thermal Efficiency (Bth), Air/Fuel (A/F) ratio, and Exhaust Gas temperature. Before the actual tests were carried out the engine was checked for lubrication and fuel supply. If the engine starting was difficult for blends, then it was run on diesel initially.

3.1.1 Determination of fuel consumption

Fuel tank is attached with a graduated burette. The

valve at the bottom of the tank is closed when fuel consumption rate is to be measured so that fuel is consumed only from the burette. The time taken for 'X' amount of fuel consumption is recorded to measure the fuel consumption rate.

3.1.2 Determination of Brake Power

The equivalent load 'W' was recorded from the calibrated circular scale incorporated in the dynamometer setup. Brake Power was obtained by using the formula

$$B.P = (\pi D W N) / 60$$

Where D is diameter of the brake drum in mm; N is speed of the engine in r/min.

3.1.3 Determination of brake thermal efficiency

$$\text{Brake Thermal Efficiency} = (B.P \times 3600) / (m_f \times C.V)$$

Where m_f is fuel consumption in kg/h; $C.V$ is calorific value of the fuel used in MJ/kg.

Specific Fuel Consumption was calculated by fuel consumption divided by the rated power output of the engine. The exhaust gas temperature was measured using a dial thermometer. The indicator on a graduated dial directly reads the temperature in °C. All the combustion parameters of fuels that are used in the engine are obtained and indicated in the following tables 2-6.

Table 2 Combustion parameters of 100% diesel

Sl no	Load /kgf	Manometer reading /cm	Time taken for 20cc of F.C /s	F.C /kg · h ⁻¹	S.F.C /kg · kWh ⁻¹	B.P/kW	Bth/%	A/F ratio	Exhaust gas temp /°C
1	0	2.5	135	0.416	—	0	0	56.4	190
2	2	2.5	98	0.573	1.154	0.496	7.45	40.9	260
3	4	2.5	85	0.661	0.670	0.992	12.83	35.5	270
4	6	2.5	75	0.750	0.503	1.488	17.1	31.3	290
5	8	2.5	68	0.826	0.416	1.984	20.65	28.4	320
6	10	2.5	61	0.921	0.372	2.480	23.15	25.5	345
7	12	2.5	60	0.936	0.314	2.977	27.35	25.06	365
8	14	2.5	58	0.968	0.279	3.473	30.85	24.2	380

Table 3 Combustion parameters of esterified Jatropha oil

Sl no	Load /kgf	Manometer reading /cm	Time taken for 20cc of F.C /s	F.C /kg · h ⁻¹	S.F.C /kg · kWh ⁻¹	B.P/kW	Bth/%	A/F ratio	Exhaust gas temp /°C
1	0	2.6	128	0.523	—	0	0	45.76	185
2	2	2.6	126	0.531	1.071	0.496	8.0	45.10	190
3	4	2.6	109	0.614	0.619	0.992	13.84	39.00	200
4	6	2.6	104	0.644	0.432	1.488	19.84	37.20	210
5	8	2.6	95	0.705	0.355	1.984	24.84	33.95	225
6	10	2.6	69	0.970	0.391	2.480	21.92	24.70	270
7	12	2.6	53	1.263	0.424	2.977	20.2	19.0	320
8	14	2.6	49	1.370	0.395	3.473	21.73	17.50	360

Table 4 Combustion parameters of 75% diesel+25% esterified Jatropha oil

Sl no	Load /kgf	Manometer reading /cm	Time taken for 20cc of F.C /s	F.C /kg · h ⁻¹	S.F.C /kg · kWh ⁻¹	B.P/kW	Bth/%	A/F ratio	Exhaust gas temp /°C
1	0	2.6	160	0.368	—	0	0	65.1	180
2	2	2.6	142	0.414	0.835	0.496	10.3	57.76	190
3	4	2.6	127	0.464	0.467	0.992	18.4	51.65	200
4	6	2.6	117	0.503	0.338	1.488	25.44	47.6	210
5	8	2.6	110	0.535	0.270	1.984	31.86	44.74	219
6	10	2.6	103	0.571	0.230	2.480	37.3	41.9	224
7	12	2.6	74	0.795	0.267	2.977	32.2	30.1	263
8	14	2.6	60	0.981	0.283	3.473	30.4	24.4	272

Table 5 Combustion parameters of 50% diesel+50% esterified Jatropha oil

Sl no	Load /kgf	Manometer reading /cm	Time taken for 20cc of F.C /s	F.C /kg · h ⁻¹	S.F.C /kg · kWh ⁻¹	B.P/kW	Bth/%	A/F ratio	Exhaust gas temp /°C
1	0	2.6	153	0.402	—	0	0	59.51	175
2	2	2.6	134	0.459	0.926	0.496	9.3	52.10	190
3	4	2.6	122	0.505	0.509	0.992	16.9	47.40	200
4	6	2.6	114	0.540	0.362	1.488	23.7	44.30	205
5	8	2.6	106	0.58	0.293	1.984	29.32	41.20	220
6	10	2.6	93	0.662	0.270	2.480	31.8	36.20	240
7	12	2.6	88	0.700	0.235	2.977	36.53	34.20	250
8	14	2.6	84	0.733	0.210	3.473	40.9	32.70	260

Table 6 Combustion parameters of 25% diesel+75% esterified Jatropha oil

Sl no	Load /kgf	Manometer reading /cm	Time taken for 20cc of F.C /s	F.C /kg · h ⁻¹	S.F.C /kg · kWh ⁻¹	B.P/kW	Bth/%	A/F ratio	Exhaust gas temp /°C
1	0	2.6	151	0.426	—	0	0	56.25	174
2	2	2.6	128	0.502	1.012	0.496	8.5	47.7	185
3	4	2.6	117	0.550	0.223	0.992	15.5	43.6	195
4	6	2.6	110	0.584	0.392	1.488	21.9	4.10	205
5	8	2.6	102	0.630	0.317	1.984	27.0	38.0	220
6	10	2.6	92	0.699	0.282	2.480	30.5	34.3	230
7	12	2.6	84	0.765	0.257	2.977	33.4	31.3	250
8	14	2.6	78	0.824	0.237	3.473	36.2	29.1	255

3.2 Performance and emissions

The performance, combustion parameters and exhaust emissions of the engine with diesel and methyl ester of Jatropha oil were presented and discussed below.

1) The Specific Fuel Consumption was calculated by fuel consumption divided by the rated power output of the engine. In Figure 3, it indicates that Specific Fuel Consumption is lower than the diesel for various proportions of Jatropha oil with diesel at constant operated conditions.

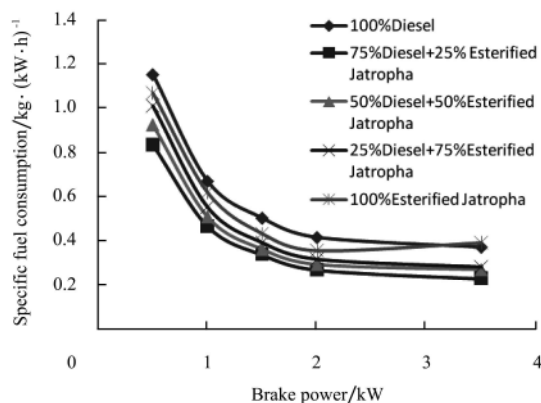

Figure 3 Variation of brake power with specific fuel consumption

This is due to complete combustion, as addition oxygen is available from fuel itself. The percent increase in Specific Fuel Consumption was increased with decreased amount of diesel fuel in the blended fuels. This may be due to higher specific gravity and lower calorific value of the biodiesel fuel as compared with diesel fuel^[6]. The calorific value of the Jatropha biodiesel was about 7 per cent lower than that of diesel fuel.

2) Brake thermal efficiency was defined as actual brake work per cycle divided by the amount of fuel chemical energy as indicated by lower heating value of fuel^[14]. The brake thermal efficiency with biodiesel and its blends was found to be slightly higher than that of diesel fuel at tested load conditions. There was no

difference between the biodiesel and its blended fuels on efficiencies. The brake thermal efficiencies of engine, operating with biodiesel mode were 22.2, 30.6 and 37.5 per cent at 2, 2.5 and 3.5 kW load conditions respectively.

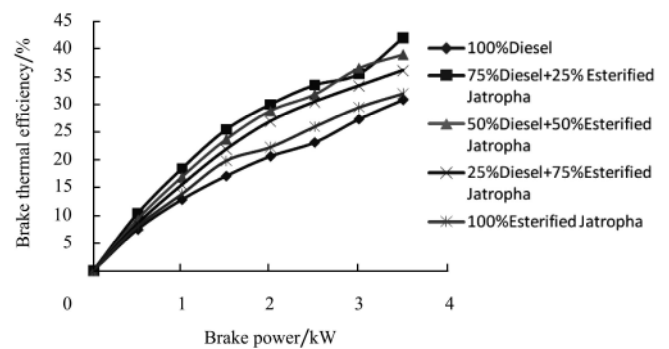

Figure 4 Variation of brake power with brake thermal efficiency

3) The exhaust gas temperature gives an indication about the amount of waste heat going with exhaust gases. The exhaust gas temperature of the different biodiesel blends was shown in Figure 5. The exhaust gas temperature of blended fuels and biodiesel at 3.5 kW load condition was 19 per cent higher than that of 2 to 2.5 kW load conditions.

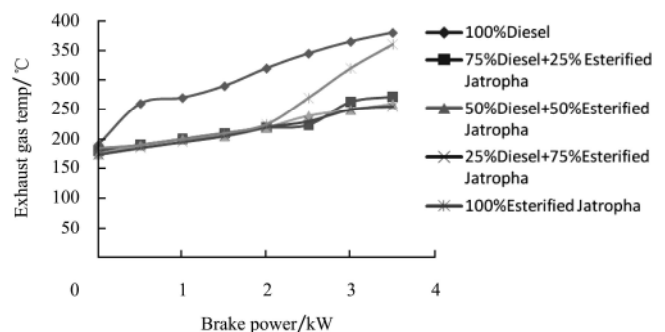

Figure 5 Variation of brake power with exhaust gas temperature

The exhaust gas temperature increased with the increase of load and amount of blended biodiesel in the fuel. The exhaust gas temperature reflects on the status of combustion inside the combustion chamber^[15]. The reason for increase in the exhaust gas temperature may be

due to ignition delay and increased quantity of fuel injected. The exhaust gas temperature can be reduced by adjusting the injection timing/injection pressure in to the diesel engine.

4) The carbon dioxide emission from the diesel engine with different blends is shown in Figure 6. The CO₂ increased with the increase of load conditions for diesel and for biodiesel blended fuels. The Jatropha biodiesel followed the same trend of CO₂ emission, which was higher than in case of diesel. The CO₂ in the exhaust gas was the same for Jatropha biodiesel blended fuels and Jatropha biodiesel.

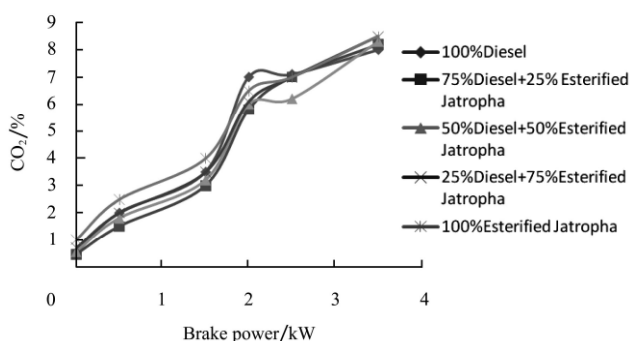

Figure 6 Variation of brake power with CO₂

5) The CO emission from the diesel fuel with biodiesel blended fuels and biodiesel is shown in Figure 7.

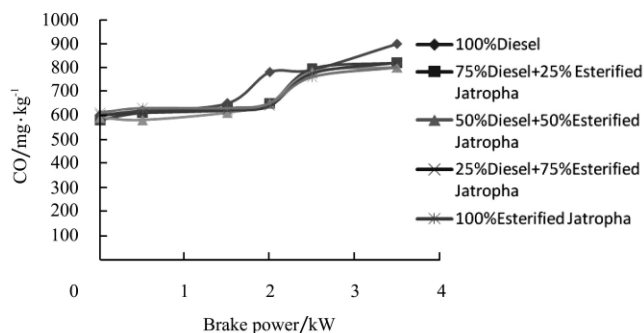

Figure 7 Variation of brake power with CO

The CO reduction by biodiesel was 17.5, 17, 16, 14 and 14 per cent at 1, 1.5, 2, 2.5 and 3.5 kW load conditions. With diesel fuel mode the lowest CO was recorded as 610 mg/kg at 1.5 kW load and as load increased to 3.5 kW, CO also increased to 898 mg/kg. Similar results were obtained for biodiesel blended fuels and Jatropha biodiesel with lower emission than diesel fuel. The amount of CO emission was lower in case of biodiesel blended fuels and biodiesel than diesel because of the fact that biodiesel contained 11 per cent oxygen molecules. This may lead to complete combustion and reduction of CO emission in biodiesel fuelled engine^[16].

6) Figure 8 shows the variation of NO_x with respect to brake power. At higher power output conditions, due to higher peak and exhaust temperatures the NO_x values are relatively higher compared to low power output conditions.

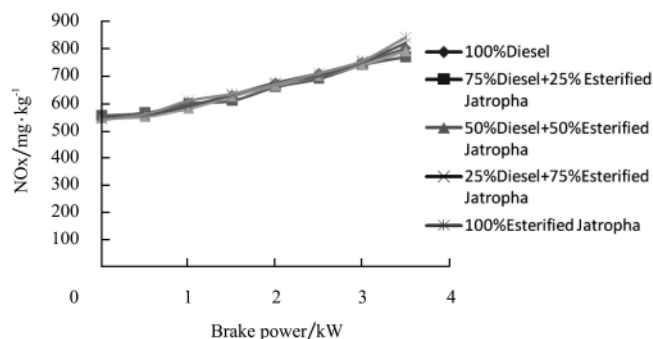

Figure 8 Variation of brake power with NO_x

A slight increase in NO_x was observed for blends of esterified Jatropha diesel compared to diesel. The reason may be due to late burning of blends of MEJ-Diesel during expansion^[17]. The reason for increase in NO_x with respect to esterified Jatropha diesel may be due to sustained and prolonged duration of combustion associated with reduction in combustion temperature.

7) Figure 9 represents the variation of smoke with respect to brake power. Smoke increases with the increase of brake power. Smoke emission was lesser for blends of esterified Jatropha diesel compared to diesel. This may be due to late burning in the expansion and exhaust. When percentage of blend of biodiesel increases, smoke density decreases, but smoke density increases for B50 and B75 due to insufficient combustion. It requires changes in injection pressure and combustion chamber design^[18].

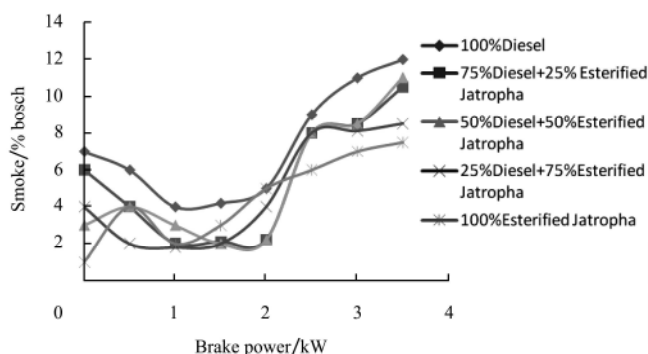

Figure 9 Variation of brake power with smoke

4 Conclusions

A single cylinder compression ignition engine was operated successfully using methyl ester of Jatropha oil as

the soul fuel. The following conclusions were made based on the experimental results.

Engine works smoothly on methyl ester of *Jatropha* oil with performance comparable to diesel operation.

Methyl ester of *Jatropha* oil results in a slightly increased thermal efficiency as compared to that of diesel.

The exhaust gas temperature is decreased with the methyl ester of *Jatropha* oil as compared to diesel.

CO₂ emission is low with the methyl ester of *Jatropha* oil.

CO emission is low at higher loads when compared with the methyl ester of *Jatropha* oil.

NO_x emission is slightly increased with methyl ester of *Jatropha* oil compared to diesel.

There is significant difference in smoke emissions when the methyl ester of *Jatropha* oil is used.

This methyl ester of *Jatropha* oil along with diesel may reduce the environmental impacts of transportation, reduce the dependency on crude oil imports, and offer business possibilities to agricultural enterprises for periods of excess agricultural production. On the whole it is concluded that the methyl ester of *Jatropha* oil will be a good alternative fuel for diesel engine for agricultural applications.

Acknowledgements

The authors thank Pollution Control Board, Vijayawada for giving permission to use exhaust analyzer and smoke meter for testing emissions coming out of the tested engine. The authors are indebted to the financial support from Koneru Lakshmaiah College of Engineering. Finally authors thank *Jatropha* oil seeds and consultants, Nalgonda for supplying the needed *Jatropha* oil.

[References]

- [1] Barnwal S. Prospects of biodiesel production from vegetable oils in India. *Renewable and Sustainable Energy Reviews*, 2005; 9: 363–378.
- [2] Vijaya Raju N, Amba Prasad Rao G, Rama Mohan P. Esterified *Jatropha* oil in Diesel Engines, Proceedings of the Sixteenth National Conference on IC engines and Combustion, Jadavpur University, January 20-22, 2000.
- [3] Altön R. An experimental investigation on use of vegetable oils as diesel engine fuels. Ph.D Thesis, Gazi University, Institute of Science and Technology, 1998.
- [4] Canakci M, Van Gerpen J H. Biodiesel production from oils and fats with high free fatty acids. *Trans of ASAE*, 2001; 44(6): 1429–1436.
- [5] Sarin R, Sharma M, Sinharay S, et al. *Jatropha* Palm biodiesel blends: An optimum mix for Asia, *FUEL*, Elsevier Journal, 2007; 86, 1365–1371.
- [6] Forson F K, Oduro E K, Hammond-Donkoh E. Performance of *Jatropha* oil blends in a diesel engine. *Renewable Energy*, 2004; 29(7): 1135–1145.
- [7] Pramanik, K. Properties and use of *Jatropha curcas* oil and diesel fuel blends in compression ignition engine. *Renewable Energy*, 2003; 28 (2): 239–248.
- [8] I.S.I. Methods of test for internal combustion engines. IS: 10000 Part I-XII. Indian Standards Institute, New Delhi. 1980.
- [9] Agarwal D, Kumar L, Agarwal A K. Performance evaluation of a vegetable oil fuelled CI Engine. *Renewable Energy*, 2008; 33(6): 1147–1156.
- [10] Patil V, Singh K. Oil gloom to oil boom. *Jatropha curcas* a promising agroforestry crop. Shree Offset Press, Nashik, India, 1991.
- [11] Harrington K J. Chemical and physical properties of vegetable oil esters and their effect on diesel fuel performance. *Biomass*, 1986; 9 (1): 1–17.
- [12] Ali Y, Hanna M A. Alternative diesel fuels from vegetable oils. *Bioresource Technology*, 1994; 50, pp 153–163.
- [13] Yamane K, Ueta A, Shimamoto Y. Influence of physical and chemical properties of biodiesel fuels on injection, combustion and exhaust emission characteristics in a direct injection compression ignition engine. *Int J Res*, 2(4).
- [14] Kumar M S, A Ramesh A. An experimental comparison of methods to use methanol and *Pongamia* oil in a compression ignition engine, *Biomass and Bio Energy*, 2003; 25: 309–318.
- [15] Takeda Y. Development study *Jatropha curcas* (Sabu Dum) oil as a substitute for diesel engine oil in Thailand. *Journal of Agricultural Association of China*, 1982; 120: 1–8.
- [16] Senthil Kumar M, Ramesh A, Nagalingam B. An experimental comparison of methods to use methanol and *jatropha* oil in a compression ignition engine. *Biomass and Bioenergy Journal*, 2003' 25(3): 309–318.
- [17] Forgiel R, Varde K S. Experimental investigation of vegetable oil utilization in a direct injection diesel engine. *SAE Alternate fuels for diesel engines. SP 500 fuels and lubricants meeting. Tulsa, OK. 1981.*
- [18] Yukitsugu I, Takeuchi R. Transesterified *curcas* oil blends for farm Diesel Engines. *Transactions of the ASAE*, 1987; 30(3): 605-609.