

# Modeling and test on height adjustment system of electrically-controlled air suspension for agricultural vehicles

Chen Yuexia<sup>1</sup>, Chen Long<sup>2\*</sup>, Wang Ruochen<sup>2</sup>, Xu Xing<sup>2</sup>, Shen Yujie<sup>1</sup>, Liu Yanling<sup>2</sup>

(1. School of Automotive and Traffic Engineering, Jiangsu University, Zhenjiang 212013, China;

2. Automotive Engineering Research Institute, Jiangsu University, Zhenjiang 212013, China)

**Abstract:** To reduce the damages of pavement, vehicle components and agricultural product during transportation, an electric control air suspension height adjustment system of agricultural transport vehicle was studied by means of simulation and bench test. For the oscillation phenomenon of vehicle height in driving process, the mathematical model of the vehicle height adjustment system was developed, and the controller of vehicle height based on single neuron adaptive PID control algorithm was designed. The control model was simulated via Matlab/Simulink, and bench test was conducted. Results show that the method is feasible and effective to solve the agricultural vehicle body height unstable phenomenon in the process of switching. Compared with other PID algorithms, the single neuron adaptive PID control in agricultural transport vehicle has shorter response time, faster response speed and more stable switching state. The stability of the designed vehicle height adjustment system and the ride comfort of agricultural transport vehicle were improved.

**Keywords:** agricultural transport vehicle, electric control, air suspension, height adjustment system, vehicle body height, single neuron adaptive PID

**DOI:** 10.3965/j.ijabe.20160902.1852

**Citation:** Chen Y X, Chen L, Wang R C, Xu X, Shen Y J, Liu Y L. Modeling and test on height adjustment system of electrically-controlled air suspension for agricultural vehicles. *Int J Agric & Biol Eng*, 2016; 9(2): 40–47.

## 1 Introduction

According to the related reports, loss rate of agricultural products in the transport process was very high in China. How to reduce the loss rate has been the

subject of the whole society and the government. Electronically Controlled Air Suspension (ECAS) can realize the automatic adjustment of body height according to the load change and the automobile movement status, and effectively improve the road irregularity excitation transfer to the body, so that to reduce the early damage of auto parts and components caused by the adverse vibration. Therefore, an electric control air suspension system can be used for agricultural transport vehicle to reduce the loss of agricultural production in the transport process, and to improve vehicle ride comfort and operational efficiency. In developed countries, more than 90% medium-sized passenger cars and more than 40% of the trucks, trailers and tractors have used air suspension system. But in China, few of agricultural transport vehicles are equipped with of air suspension. Therefore, it is necessary to carry out research in this area. ECAS can adjust air spring height according to the actual working conditions, which can change the body height and stiffness characteristics of air spring, so the body

**Received date:** 2015-04-13 **Accepted date:** 2016-03-03

**Biographies:** **Chen Yuexia**, PhD, research interest: vehicles integrated chassis control of vehicle dynamics, Email: cyx08@126.com; **Wang Ruochen**, PhD, Professor, research interest: vehicle dynamic performance simulation and control, Email: wrc@ujs.edu.cn; **Xu Xing**, PhD, Associate Professor, research interest: dynamic system modeling, identification, optimization, fault diagnosis and control, Email: xuxing7904@163.com; **Shen Yujie**, PhD, research interest: vehicles integrated chassis control of vehicle dynamics, Email: shenyujie@ujs.edu.cn; **Liu Yanling**, PhD, Lecturer, research interest: vehicles integrated chassis control of vehicle dynamics, Email: liuyyl@ujs.edu.cn.

**\*Corresponding author:** **Chen Long**, PhD, Professor, research interest: vehicles integrated chassis control of vehicle dynamics, School of Automotive and Traffic Engineering, Jiangsu University, 301 Xuefu Road, Zhenjiang 212013, China, Email: chenlong@ujs.edu.cn.

height control is particularly important.

At present, the studies on structure and control of air suspension vehicle body height system have been investigated by many scholars. Burton et al.<sup>[1]</sup> studied the analysis, modeling and control of an automatically adjust the suspension height of vehicle active suspension system. Wang et al.<sup>[2]</sup> established eight degrees of freedom vehicle mathematical model, and put forward the theory analysis and calculation methods of vehicle body height and the damping integrated control, and designed the adjustable damping shock absorber and vehicle integration control air suspension system. Campbell et al.<sup>[3]</sup> proposed using number of driving wheel and the body comprehensive implementation body height adjustment, at the same time setting the speed threshold, piecewise realized different body heights. Bemporad et al.<sup>[4]</sup> designed body height control system, using the theory of hybrid control theory, and completed the system process design. Yang et al.<sup>[5]</sup> designed and developed the bus of electronically controlled air suspension height control system based on CAN. Kim et al.<sup>[6]</sup> adopted the automatic control system to keep the body height and made the simulation by ADMAS. Song<sup>[7]</sup> developed a multi-body dynamic model of an air suspension vehicle based on Lagrange method and performed a ride height simulation under step input using PID and PD control strategy. Bao et al.<sup>[8]</sup> derived the mechanics equations for air spring, leveling valve and connecting pipe sub-modules, and proposed a modulized model for coupled air springs suspension, which takes into account the effects of nonlinearity such as the dead zone and saturation characteristics in leveling valve and the non-steady flow in connecting pipe. Bjorn et al.<sup>[9]</sup> proposed the optimal height control based on the rear axle shaft load response. Kim et al.<sup>[10]</sup> proposed two different ways of the air suspension height control, the asynchronous control and the synchronous control, to handle the model uncertainties. Yu et al.<sup>[11]</sup> carried out simulation study on the fuzzy control of automotive air suspension. This control strategy can obtain better effects on vehicle body height. When the system structure parameters varied, the controller shows good robustness. He et al.<sup>[12]</sup> created the fuzzy controller of

body height adjustment. Xu et al.<sup>[13]</sup> designed a height tracking circuit based on the inductance sensor<sup>[14]</sup>, then combined with the variable mass filling gas system of thermodynamics and the theory of vehicle dynamics, established the mathematical model of body height adjustment for the air suspension bus, put forward the gearshift integral PID/PWM height control strategy, and carried out simulation and experiment. Sun et al.<sup>[15]</sup> proposed a hybrid approach to adjust the vehicle height by controlling the on-off statuses of solenoid valves directly, and showed the advantages by simulation and experimental results. But most of the involved vehicles in these studies were passenger vehicles.

Because of its bad highway condition, the damages of severe shock for body parts and agricultural products are huge. Therefore, the ride comfort should be considered. The agricultural vehicle height adjustment is expected to be continuous, fast and stable, which is usually carried out on a very unstable condition. The existing researches<sup>[1-9]</sup> focused on height switching model and realization of different height switching with ignoring the stability of height switching. The researches of Kim, et al.<sup>[10-15]</sup> have made up the gap in switching accuracy and stability, but the road excitation is relatively stable<sup>[10,11,15]</sup>, and some models were established in static state<sup>[12-14]</sup>. In studying high switching stability, the performance of controller<sup>[12-14]</sup> was verified on increasing and reducing process respectively, ignored the effect of continuous controlled process. Sun et al.<sup>[15]</sup> studied the stability of continuous increasing and reducing process, but they relatively ignored the time delay of the controller and vehicle ride comfort.

Based on the above shortcomings, in this research, an improved single neuron adaptive PID control algorithm based on the above control strategy was proposed to apply to the ECAS height adjustment system of agricultural transport vehicle. Then, the mathematical model of the vehicle height adjustment system was developed, and the controller of vehicle height based on single neuron adaptive PID control algorithm was designed. In addition, simulation and bench test were carried out. Attention is focused on the control performance of the proposed controller and vehicle ride

comfort. The final section summarizes the most important findings of the study.

## 2 Control model for air suspension height adjustment

ECAS height adjustment system mainly includes gas tank, controller, air spring, exhausted solenoid valve, filled solenoid valve, height sensor, vehicle body and shock absorber. The height adjustment process is a complex nonlinear dynamic process, which concern inflating and deflating circuit of air spring. The structure schematic diagram is shown in Figure 1.

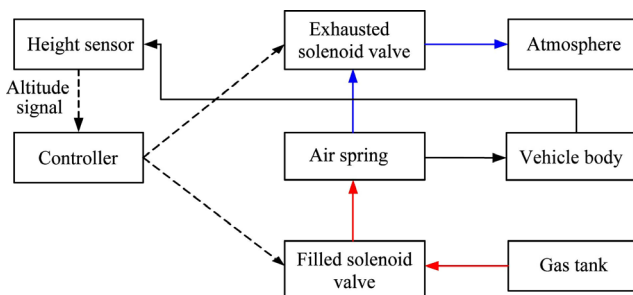

Figure 1 Inflating and deflating circuit structure diagram of ECAS system

The working process of vehicle body height adjustment system is as follows: when vehicle body height transmitted from height sensor is greater than the target height, then exhausted solenoid valve is opened by signal from controller. The compressed gas in storage tank is pushed into the air spring through the pipeline and exhausted solenoid valve, and then the body height increases. When vehicle body height transmitted from height sensor reaches the target height, the controller gives a signal to close the exhausted solenoid valve; when vehicle body height transmitted from height sensor is less than the target height, the controller gives a signal to open the filled solenoid valve. Then gas in the air spring flows into the atmosphere through pipelines and the filled solenoid valve, and the height of the body decreases. When vehicle body height transmitted from height sensor reaches the target height, the controller gives a closed signal to filled solenoid valve.

Rational simplification of inflating and deflating process, assumptions are as follows:

- (1) Gas is ideal;
- (2) No leakage in the gas path;

(3) Pressure and temperature of the air in air spring are uniform;

(4) Air tank is a gas source with constant temperature, constant pressure and constant volume;

(5) Calculation of the electromagnetic valve in loop as the equivalent throttle orifice.

Solenoid valve is opened, the mass flow rate in the pipeline are shown as follows<sup>[13,14]</sup>:

$$Q_m = \begin{cases} \beta S p_u \left( \frac{2}{\alpha + 1} \right)^{\frac{\alpha + 1}{2(\alpha - 1)}} \sqrt{\frac{\alpha}{RT_u}} & 0 < \frac{p_d}{p_u} < \sigma \\ \beta S p_u \left( \frac{2}{\alpha - 1} \right)^{\frac{1}{2}} \sqrt{\frac{\alpha}{RT_u}} \left( \frac{p_d}{p_u} \right)^{\frac{1}{\alpha}} \sqrt{1 - \left( \frac{p_d}{p_u} \right)^{\frac{\alpha - 1}{\alpha}}} & \sigma \leq \frac{p_d}{p_u} < 1 \end{cases} \quad (1)$$

where,  $Q_m$  is mass flow rate,  $m^3/s$ ;  $\beta$  is the gas flow resistance coefficient;  $S$  is the equivalent cross-sectional area through electromagnetic valve,  $m^2$ ;  $\alpha$  is gas adiabatic exponent;  $R$  is the gas constant,  $N \cdot m / (kg \cdot K)$ ;  $p_u$  is absolute pressure of the upper end, kPa;  $p_d$  is absolute pressure of the downstream end, kPa;  $T_u$  is thermodynamic temperature of the upper end of gas, K;  $\sigma$  is the critical gas pressure ratio.

Inflating and deflating process of air spring is a variable volume adiabatic process. According to the first law of thermodynamics, inflating and deflating air spring model can be established as follows:

$$\alpha RT_t \frac{dm_t}{dt} = V_t \frac{dp_t}{dt} + \alpha p_t \frac{dV_t}{dt} \quad (2)$$

where,  $T_t$  is the temperature of the air spring, K;  $\frac{dm_t}{dt}$  is mass flow of the gas in and out the spring,  $m^3/s^2$ ;  $V_t$  is air spring volume,  $m^3$ ;  $p_t$  is absolute pressure of air spring,  $N \cdot m^2$ .

The volume of air spring is given by,

$$V_t = V_0 + \mu x \quad (3)$$

then,

$$\frac{dV_t}{dt} = \mu \frac{dx}{dt} \quad (4)$$

where,  $V_0$  is the initial volume of air spring;  $\mu$  is air spring volume change rate;  $x$  is air spring height variation, m.

As electromagnetic valve is closed, air spring changes into a closed constant quality system, then,  $\frac{dm_t}{dt} = 0$ .

From Equation (2), air spring model can be written now as:

$$\frac{dV_t}{dt} = \frac{V_t}{\alpha p_t} \frac{dp_t}{dt} \quad (5)$$

Simplifying the model for research needs, the change of air spring height can approximately equal to body height variation, the pavement and the tire are considered as a whole, and integrated into the random road excitation. According to Newton's law, the kinetic equation of 1/4 air suspension in Figure 2 is given by:

$$m \frac{d^2x}{dt^2} + mg = C \frac{dx}{dt} + p_e A_e - g(\omega) \quad (6)$$

where,  $m$  is the sprung mass, kg;  $C$  is shock absorber damping coefficient, N·s/m;  $p_e$  is air spring relative pressure, N·m<sup>2</sup>;  $A_e$  is the effective area of air spring, m<sup>2</sup>;  $g(\omega)$  is random road excitation as nonlinear expressions about Gauss white noise.

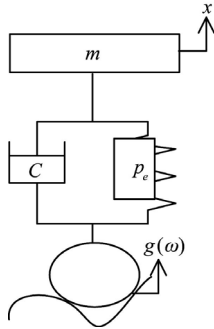

Figure 2 Air suspension model

The mathematical model of vehicle height adjusting in inflating and deflating process of ECAS system is developed combining with the above equation.

### 3 Control strategy for height adjusting

As the basic unit of neural network structure, single neuron has the self-learning and adaptive ability, and the structure is simple and easy to calculate. Traditional PID has the advantages of simple structure, convenient adjustment, parameter tuning contact with the engineering index closely, but the choice of traditional PID regulator parameters mainly depend on repeated tests and experience, when the state of the object changes. For reconstructing the traditional PID controller using adaptive and self-learning capability of neural network<sup>[16-19]</sup>, the control system has strong adaptability, and can control the complex system better. The single

neuron adaptive PID (SNA-PID) controller structure is shown in Figure 3.

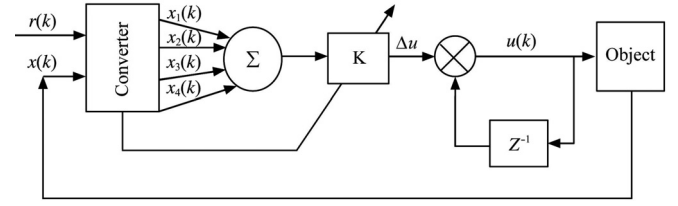

Figure 3 Single neuron adaptive PID controller structure

In the diagram,  $x(k)$  is displacement of sprung mass at  $k$  moment;  $r$  is the reference value;  $K$  is the proportional coefficient of neuron,  $K > 0$ .

For the rapid controlling and repeated positioning precision of the control system, the input of the SNA-PID controller is given by the following:

$$\begin{cases} x_1(k) = e(k) = r(k) - x(k) \\ x_2(k) = \Delta e(k) = e(k) - e(k-1) \\ x_3(k) = e(k) - 2e(k-1) + e(k-2) \\ x_4(k) = \Delta r(k) = r(k) - r(k-1) \end{cases} \quad (7)$$

In order to eliminate the oscillation caused by frequent control, the rational dead zone is set for position tracking error according to the requirements of the actual height control accuracy.

$$e(k) = \begin{cases} 0 & |e(k)| \leq \varepsilon \\ e(k) & |e(k)| > \varepsilon \end{cases} \quad (8)$$

where,  $e(k)$  is the position tracking error;  $\varepsilon$  is an adjustable parameter, let  $\varepsilon = 2$  mm.

This study uses a single neuron adaptive PID control algorithm with supervised Hebb learning rule. When

the performance index  $J(k) = \frac{1}{2} [r(k) - x(k)]^2$ , the

SNA-PID control algorithm is written as:

$$\begin{cases} \Delta u(k) = K(k) \sum_{i=1}^4 \omega'_i(k) x_i(k) \\ \omega'_i(k) = \frac{\omega_i(k)}{\sum_{i=1}^4 |\omega_i(k)|} \\ \omega_1(k) = \omega_1(k-1) + \eta_I z(k) u(k) [e(k) + \Delta e(k)] \\ \omega_2(k) = \omega_2(k-1) + \eta_P z(k) u(k) [e(k) + \Delta e(k)] \\ \omega_3(k) = \omega_3(k-1) + \eta_D z(k) u(k) [e(k) + \Delta e(k)] \\ \omega_4(k) = \omega_4(k-1) + \eta_R z(k) u(k) [e(k) + \Delta e(k)] \end{cases} \quad (9)$$

where,  $z(k) = r(k) - x(k) = e(k)$ , and  $K(k)$  is gain of the controller;  $\omega_i$  are neuron weights;  $\eta_P$ ,  $\eta_I$ ,  $\eta_D$ ,  $\eta_R$  are learning rate of feedback proportion, feedback integral,

feedback differential, and feedforward proportion, the values of them in this model are 0.75, 0.3, 0.6 and 0.2, respectively.

For the changeable and random of control system, the adaptive PSD control algorithm<sup>[20]</sup> and single neuron adaptive PID intelligent controller is combined to form a single neuron adaptive PID controller with automatically adjusting the gain of  $K$ , to further improve the self-learning, self-organizing ability and robustness of the controller.

The controller gain is calculated as follows:

$$K(k) = \begin{cases} K(k-1) + C \frac{K(k-1)}{T_v(k-1)}, & \text{sgn } e(k) = \text{sgn } e(k-1) \\ 0.75K(k-1), & \text{sgn } e(k) \neq \text{sgn } e(k-1), \end{cases} \quad (10)$$

where,  $T_v(k) = T_v(k-1) + L \text{sgn} [|\Delta e(k)| - T_v(k-1)|\Delta^2 e(k)|]$ ,  $0.05 \leq L \leq 0.1$ ,  $0.025 \leq C \leq 0.05$ . In this model, set

initial value  $K(0)=0.5$ . According to the regulation rules of controller, the output in this model has a large overshoot, and repeated sine attenuation phenomenon,  $K$  is decreased automatically.

### 4 Simulation and bench test

According to the above derivation and neural network PID control algorithm, the air suspension vehicle height adjustment model is developed to simulate the body height adjustment via Matlab/Simulink (Figure 4). The one-quarter bench-test system which consisted of the console and bench is built to verify the actual performance of the designed controller (Figure 5). According to the characteristics of road of the agricultural transport vehicle, the road roughness coefficient of cobbled road is set as  $G_0=1.7 \times 10^{-5} \text{ m}^3/\text{cycle}$ , and vehicle speed is 40 km/h, then, random road excitation is shown in Figure 6. The main parameters of vehicle are shown in Table 1.

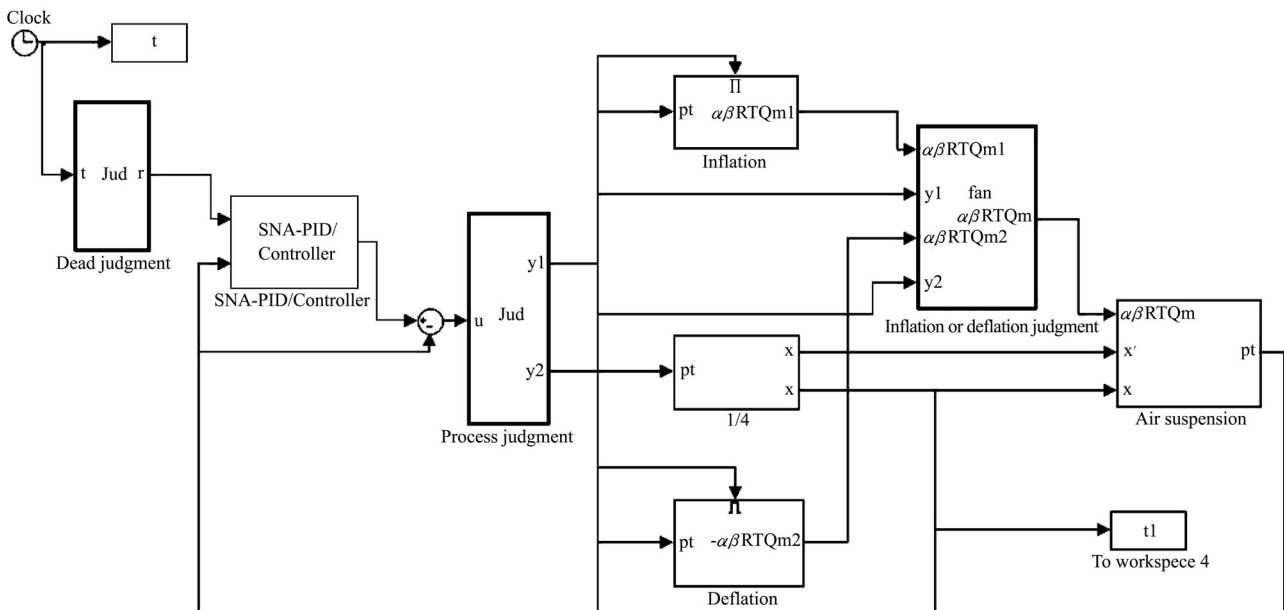

Figure 4 Body height simulation control system



Figure 5 Structural diagram of one-quarter bench-test system

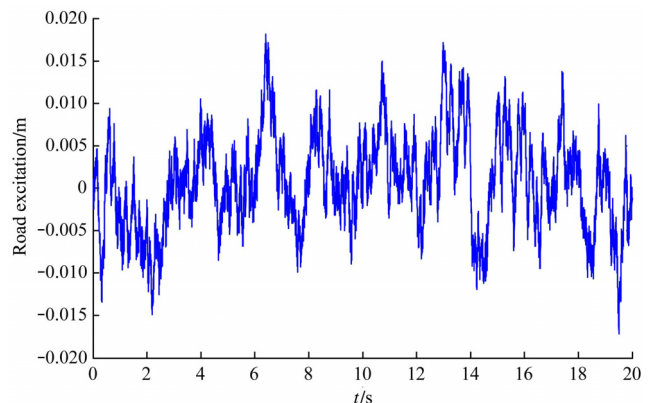

Figure 6 Random road excitation

**Table 1 Main parameters of the vehicle**

Parameter	Value
Body mass $m/\text{kg}$	330
Damping coefficient of the damper $C/\text{N}\cdot\text{s}\cdot\text{m}^{-1}$	3900
Effective area of air spring $A_e/\text{m}^2$	0.009
Initial volume of air spring $V_0/\text{m}^3$	0.0022
Equivalent cross-sectional area through electromagnetic valve $S/\text{m}^2$	0.000004

In order to observe the effect of controller more carefully, the continuous deflating-inflating process is investigated by simulation and test.

**4.1 Simulation results and analysis**

The process is set as follows: set the initial position

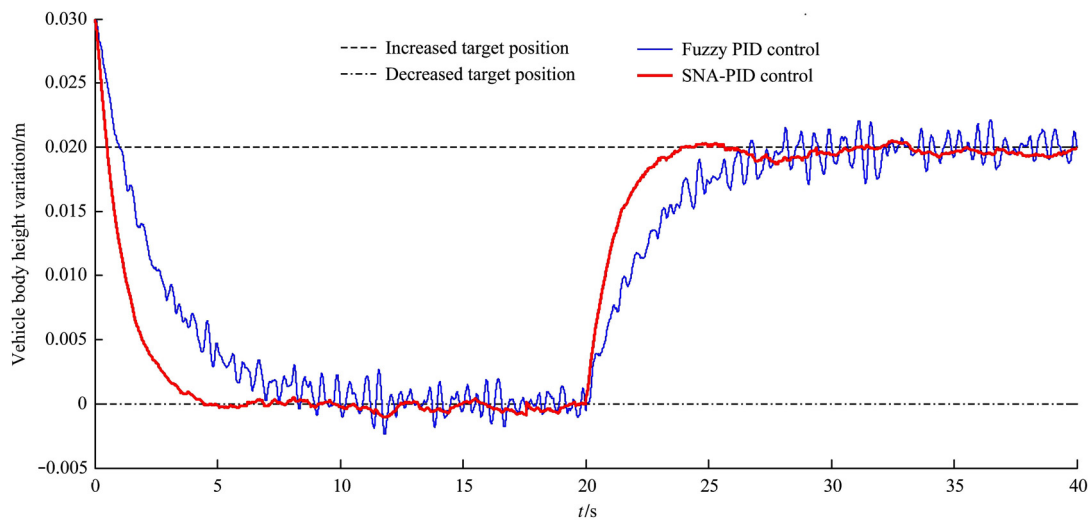

Figure 7 Simulated curves of vehicle body height

It can be seen from Figure 7 that fuzzy PID controlled height adjustment has the obvious “over-inflating”, “over-deflating” and oscillation phenomena, and that affects height switching accuracy, and SNA-PID control have obviously alleviated the above adverse phenomena, so the height switching is relatively stable. In contrast with the fuzzy PID control, the SNA-PID controlled height reaches the target height faster both in deflating and inflating processes.

**4.2 Bench test results and analysis**

In order to test the performance of the controller more comprehensively, an inflating-deflating process is set in this part. A similar operation process is taken as the simulation process, setting the initial value  $t=0, x=0$ , and controller gives an inflating signal, the increased target height  $x=0.03$ ; when  $t=15$ , controller gives an deflating signal, the decreased target height  $x=0.01$ .

The test curves of vehicle’s body with fuzzy PID and SNA-PID control are shown in Figure 8, and the body

$t=0, x=0.03$ , the controller gives an opened signal to exhausted solenoid valve, and as vehicle body height transmitted from height sensor reaches the target height  $x=0$ , the controller gives a closed signal to exhausted solenoid valve; when  $t=20$ , the controller gives an opened signal to filled solenoid valve, and as vehicle body height is raised to the target height  $x=0.02$ , the controller gives a closed signal to filled solenoid valve.

Simulation results for controller performance are shown in Figure 7, and for comparison, the fuzzy PID controller is designed.

acceleration curves are given in Figure 9.

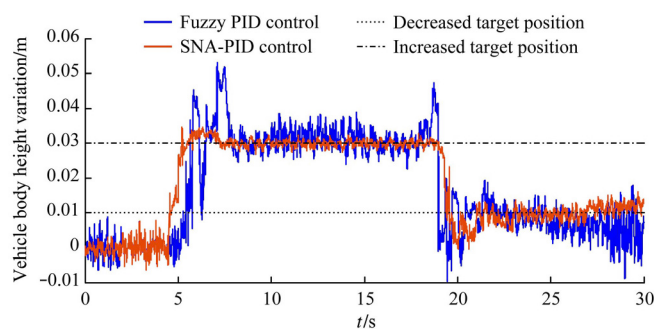

Figure 8 Test curves of vehicle body height

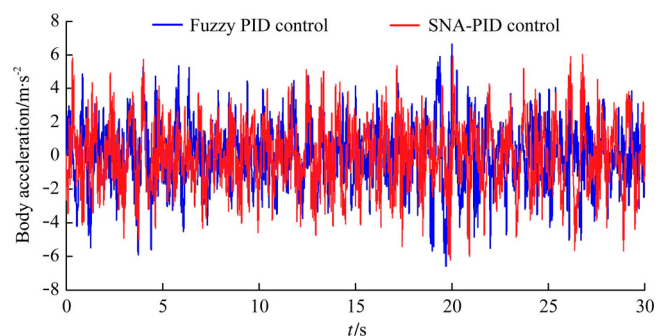

Figure 9 Body acceleration

From the Figure 8, compared with the simulation results, there are more obvious “over-inflating”, “over-deflating” and oscillation phenomena in fuzzy PID controlled height adjustment system, and the above phenomena have been significantly weakened in SNA-PID control system. The SNA-PID control is keeping height switching stable in deflating-inflating continuous process, while fuzzy PID control oscillates frequently by a wide margin. Compared with the fuzzy PID control, the SNA-PID control system reaches the target height early. Thus, the SNA-PID controller has shorter response time, faster response speed and more stable switching state. In the meanwhile, it is inferred from the Figure 9 that the body acceleration in SNA-PID control is better than that of fuzzy PID control, the ride comfort of agricultural transport vehicle is improved.

## 5 Conclusions

1) Based on a random road excitation for driving conditions of agricultural vehicles, the model of the vehicle height adjusting system was established by the characteristic of the air spring combined with vehicle dynamics, and then the SNA-PID control strategy was proposed.

2) The SNA-PID controller of body height adjustment was designed. Matlab/Simulink simulation and bench test were carried out. Simulation and experimental results show that the method is feasible and effective to solve the unstable phenomenon of agricultural vehicle body height in the process of switching. It makes height adjustment system and performance better match.

3) Compared with other PID algorithms, the SNA-PID control in agricultural transport vehicle has shorter response time, faster response speed and more stable switching state. Therefore, the ride comfort of agricultural transport vehicle is improved. Because of the complexity of the body height adjustment system and the other reasons, the actual application of this method needs more practice test. It is the ongoing work of the next research.

## Acknowledgements

Project supported by the National Natural Science

Foundation of China (Grant No. 51375212, 71373105), Research Fund for the Doctoral Program of Higher Education of China (Grant No. 20133227130001), Research and Innovation Project for College Graduates of Jiangsu Province of China (Grant No. CXZZ12\_0663), Jiangsu Provincial Natural Science Foundation of China (Grant No. BK20131255), A Project Funded by the Priority Academic Program Development of Jiangsu Higher Education Institutions.

## [References]

- [1] Burton A W, Truscott A J, Wellstead P E. Analysis, modeling and control of an advanced automotive self-leveling suspension system. *IEE Proc.-Control Theory Appl.*, 1995; 142(2): 129–139.
- [2] Wang R C, Zhang X L, Chen L, Zhu X. Integrated control system of vehicle body height and adjustable damping. *Transactions of the CSAE*, 2012; 28(11): 75–79. (in Chinese with English abstract)
- [3] Campbell D C, Gloceri G J, Mccoy D M, Reichenbach T G, Duchnowski L J, Ivan J C, et al. Ide height setting based on transfer case setting. U.S. Patent, 1997, No.5593176.
- [4] Bemporad A, Morari M. Verification of hybrid systems via mathematical programming. *Hybrid Systems: Computation and Control*, 1999; 1569: 31–45.
- [5] Yang L, Chen S Z, Wu Z C, Zhang B. Design on bus air suspension height of electronic control system. *Beijing Automotive Engineering*, 2007; 2: 4–7.
- [6] Kim W, Lee J W, Kim H K, Doo M S, Kim H S. Handling Analysis of Height control and ECS. *Korea ADAMS User Conference*, 2001; pp.1–9.
- [7] Song Y. Study on ride height PID control technology of air suspension vehicle. *Journal of Hubei Automotive Industries Institute*, 2007; 21(2): 1–4.
- [8] Bao W N, Chen L P, Zhang Y Q. A study on dynamics model for coupled air springs suspension system. *Automotive Engineering*, 2008; 30(3): 231–234.
- [9] Bjorn O S, Darris W. Electronic height control. U.S. Patent, 2005, No.6959932B2.
- [10] Hyunsup K, Hyunsup K, Hyeongcheol L. Asynchronous and synchronous load leveling compensation algorithm in airspring suspension. *Control, Automation and Systems*, 2007; 10: 367–372.
- [11] Yu W B, Zhang L Z, Li N. Study of the fuzzy control of air suspension of vehicle height system. *Electronic Instrumentation Customer*, 2006; 13(2): 6–8.
- [12] He E B, Du Q G, Feng Y Y. Fuzzy-PID control of body height adjustment for vehicles with electrically controlled air

- suspension. *Machine Tool & Hydraulics*, 2012; 40(5): 86–88.
- [13] Xu X, Chen Z Z, Quan L, Li Z X, Zhou K K. Real-time tracking of ride height for bus with electronically controlled air suspension. *Journal of Mechanical Engineering*, 2011; 47(2): 136–141.
- [14] Xu X, Chen Z Z, Li Z X, Huang J M, Zhou K K. Investigation on modeling and control of body height adjustment for bus with electrically controlled air suspension. *Automobile Technology*, 2009; 11: 42–46.
- [15] Sun X Q, Cai Y F, Wang S H, Liu Y L, Chen L. A hybrid approach to modeling and control of vehicle height for electronically controlled air suspension. *Chinese Journal of Mechanical Engineering*, 2016, 29(1): 152 - 162.
- [16] Cao T, Zheng Y. Method for determining neural network characteristic parameters in fault diagnosis system for wind turbines. *Journal of Drainage and Irrigation Machinery Engineering*, 2014; 32(3): 247–251.
- [17] Liu G D. Working conditions diagnosis of surface-driving progressive cavity pump wells based on support vector machine. *Journal of Drainage and Irrigation Machinery Engin*, 2014; 32(2): 125–129.
- [18] Guan H O, Du S H, Xu S H, Zuo Y H. Detection model of unfertilized egg based on improved projection pursuit and fuzzy neural network. *Journal of Jiangsu University (Natural Science Edit)*, 2013; 34(2): 171–177.
- [19] Cai G L, Yao Q, Jiang S Q. Global synchronization of cellular neural network with time delays by modified sliding mode control method. *Journal of Jiangsu University (Natural Science Edit)*, 2014; 35(3): 366–372.
- [20] Marsik J, Strejc V. Application of identification-free algorithms for adaptive control. *Automatica*, 1989; 25(2): 273–277.