

# Responses of electrical properties of tea leaves to low-temperature stress

Lu Yongzong<sup>1</sup>, Hu Yongguang<sup>1\*</sup>, Zhang Xiliang<sup>2</sup>, Li Pingping<sup>3</sup>

(1. School of Agricultural Equipment Engineering, Jiangsu University, Zhenjiang 212013, China;

2. School of Mechanical Engineering, Jiangsu University, Zhenjiang 212013, China;

3. College of Biology and the Environment, Nanjing Forestry University, Nanjing 210037, China)

**Abstract:** Critical temperature is one of the most important parameters for the control of crop frost protection through airflow disturbance. It changes with complex weather conditions, thus it is difficult to be determined. A method of testing electrical property of tea leaves under cold stress was put forward to indicate critical temperature. The testing system was established to measure the capacitance, impedance, resistance and reactance of the samples under different air temperatures, air humidities and airflow velocities. The variation of the electrical property was also analyzed. The results show that at humidity below 70% and airflow velocity of 0 m/s the impedance and resistance increased slowly, while the reactance kept steady when air temperature decreased from 8.0°C to around -6.3°C, and then increased rapidly from around -6.3°C to -15.0°C. There were no significant differences of the above parameters and variation trend under different airflow velocities. There was an exponential relationship between the impedance and the temperature. The capacitance was rather small and almost no change occurred with air temperature under different conditions of air velocity and humidity, except a few abrupt peaks. The maximum peak capacitance was representative of its response at certain humidity and airflow velocity. The typical temperatures were close to a range, where the other three parameters began to increase rapidly. The typical temperature dropped to the lowest of -7.8°C at the airflow velocity of 0 m/s. Therefore, the characteristic response of the capacitance could indicate critical temperature of tea leaves.

**Keywords:** low-temperature stress, electrical property, capacitance, *Camellia Sinensis*, critical temperature

**DOI:** 10.3965/j.ijabe.20150805.1426

**Citation:** Lu Y Z, Hu Y G, Zhang X L, Li P P. Responses of electrical properties of tea leaves to low-temperature stress. Int J Agric & Biol Eng, 2015; 8(5): 170–175.

## 1 Introduction

Tea plants (*Camellia Sinensis*) grow well in humid and warm hilly areas and sprout at air temperature above 10°C during the early spring<sup>[1]</sup>. Cold injuries greatly reduce tea production and quality, resulting in a huge economic loss to tea industry<sup>[2]</sup>. Mechanized frost

protection equipment through airflow disturbance and irrigation has been applied in tea fields and orchards, such as anti-frost fans, large wind machines, helicopters and sprinklers<sup>[3-5]</sup>.

Ribeiro and Snyder et al.<sup>[6,7]</sup> pointed out that critical temperature was one of the most crucial parameters for the control of the above equipment, and the decision to start wind machines was based on the minimum temperature forecast and knowledge of the critical damage temperature, which depends on the crop and its phenological stage. Hu<sup>[8]</sup> put forward a strategy for the control of wind machines based on critical temperature and thermal inversion strength, which met the requirements of necessary and sufficient conditions for the start or stop of the machines. Critical temperature of certain crops changes with many factors, such as ambient humidity, wind speed and ice nucleation active bacteria<sup>[9]</sup>. Therefore, it is variable under different conditions and is

**Received date:** 2014-09-28 **Accepted date:** 2015-09-29

**Biographies:** **Lu Yongzong**, PhD Candidate, Research interest: electrical measurement of plant under environmental stress, Email: 2111516007@ujs.edu.cn; **Zhang Xiliang**, PhD, Professor, Research interest: instrumentation and automation, Email: zhangxl@ujs.edu.cn; **Li Pingping**, PhD, Professor, Research interest: agro-biological environment, Email: lipingping@ujs.edu.cn.

**\*Corresponding author:** **Hu Yongguang**, PhD, Professor, Research interest: agro-biological environmental engineering, monitoring and control of frost protection. Mailing address: 301 Xuefu Road, Zhenjiang 212013, China. Tel: +86-511-88797338, Email: deerhu@ujs.edu.cn.

difficult to be quantitatively determined. Mills et al.<sup>[10]</sup> developed a simple test system based on differential thermal analysis (DTA) to provide the identification of critical temperatures for dormant grapevine buds and canes. Yang et al.<sup>[11]</sup> conducted an experiment to study the relationship between cold hardiness and semi-lethal temperature of tea leaves through relative electrical conductivity (REC). Meng et al.<sup>[12]</sup> measured the super-cooling and freezing points of almond floral organ in an artificial frost chamber and found that super-cooling point could indicate critical temperature, and critical temperature of almond petals was around  $-5^{\circ}\text{C}$ . However the above measurements of critical temperature are not ease of operation and the influence of ambient conditions is ignored.

Plant electrical properties have been widely used to monitor the growth and physiological process, especially to indicate the environmental stresses. Robert et al.<sup>[13]</sup> reported that resistance of elm trunks increased when infected with *Ceratocystis ulmi*. Criteria were given for prediction of the disease from 2 to 12 days prior to symptom expression. Zhang et al.<sup>[14]</sup> found the resistance of the maize stems changed with the sap density and discussed its relationship with water deficit. Water loss of the plants had influence on the electrical properties whether they were living or in vitro, and the decrease of capacitance and the increase of resistance were obvious with the water loss<sup>[15]</sup>. In plants with anion and potassium conductance blocked, dose-dependent voltage transients were evoked by cold stimuli. Temperature drop elucidated membrane potential changes due to calcium influx both from external and internal stores<sup>[16]</sup>. The study by Zhang et al.<sup>[17]</sup> showed that the electrical impedance spectroscopy (EIS) method was consistent with REC when measuring the frost hardiness of peach branches.

Low-temperature stress on the tea leaf causes its internal physiological disorder due to the change of cell structure, morphology and some substances. The leaf takes on certain dielectric properties under an electric field<sup>[18]</sup>. Therefore, its physiological responses to low temperature could be expressed by the measurement of its electrical properties.

The objective of the study was to put forward a testing method of tea leaf's electrical property and find an indicator of tea leaf's critical temperature through responses of the electrical property to low-temperature stress. The testing system was established to measure the capacitance, impedance, resistance and reactance of the leaves under different conditions of air temperature, air humidity and airflow velocity. Then the characteristics of the above parameters were found out to correlate with critical temperature under low-temperature stress.

## 2 Materials and methods

### 2.1 Materials

Sampled tea trees, aged about three years, were planted in a field plastic house on Maichun tea farm in Danyan, Jiangsu Province (Latitude  $32^{\circ}01'33''\text{N}$ , Longitude  $119^{\circ}40'28''\text{E}$ , Altitude 14 m). The variety Fuding Dabai was early-maturing and vulnerable to freeze injury. Nine branches with healthy leaves were sampled on March 20, 2014, when the ambient temperature was  $8.0^{\circ}\text{C}$ . The samples were kept fresh for electrical property test in the laboratory.

The testing system of tea leaf electrical property is shown in Figure 1, which consisted of a constant-temperature incubator MIR253 (Sanyo, Japan; accuracy  $\pm 0.5^{\circ}\text{C}$ ,  $-16$ - $50^{\circ}\text{C}$ ), a temperature and humidity recorder ZDR-3WIS (Hangzhou Zeda, China; accuracy  $\pm 0.1^{\circ}\text{C}$ ,  $-50$ - $100^{\circ}\text{C}$ ), a high-precision LCR tester 3532-50 (Hioki, Japan), a computer for data acquisition and analysis, a four-terminal Kelvin probe 9140 (Hioki, Japan), a speed-adjustable fan and a humidifier. The specifications of the LCR tester are shown in Table 1.

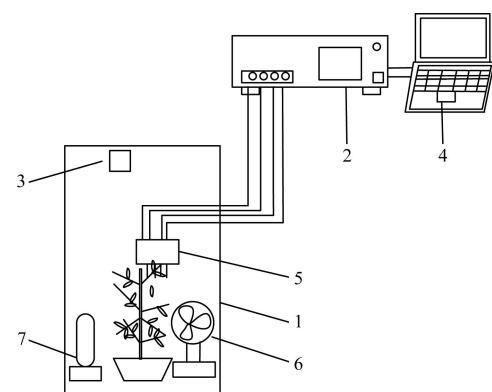

1. Constant-temperature incubator 2. LCR tester 3. Temperature and humidity recorder 4. Computer 5. Four-terminal Kelvin probe 6. Speed-adjustable fan 7. Humidifier

Figure 1 Testing system of tea leaf electrical property

**Table 1 Specifications of LCR tester**

Measurements	Measuring range
$ Z , R, X$	10.00 m $\Omega$ –200.00 M $\Omega$
$\theta$	–180.00°–+180.00°
$C$	0.32 pF–380.00 F
$L$	16.00 nH–750.00 kH
Excitation frequency	DC 42 Hz–5 MHz
Basic Accuracy	Z: $\pm 0.08\%$ ; $\theta$ : $\pm 0.05^\circ$

## 2.2 Methods

### 2.2.1 Treatments of the low-temperature stress

Tea leaves were treated under the low temperature within  $-15.0^\circ\text{C}$  to  $8.0^\circ\text{C}$ , expected humidity and airflow velocity in the incubator. The treatments of humidity and airflow velocity are listed in Table 2. The initial temperature inside the incubator was set to  $8.0^\circ\text{C}$ . It decreased to  $2.0^\circ\text{C}$  at a rate of  $4.0^\circ\text{C}/\text{h}$ , and then decreased to  $-15.0^\circ\text{C}$  at a rate of  $2.0^\circ\text{C}/\text{h}$ . A humidifier and a speed-adjustable fan were used to achieve the above humidity and airflow velocity.

**Table 2 Treatment of humidity and airflow velocity**

Airflow velocity/ $\text{m}\cdot\text{s}^{-1}$	Air humidity/%
0	below 70
1.5	70–90
2.5	above 90

### 2.2.2 Testing of electrical property

Given a specific humidity, the capacitance, impedance, resistance and reactance of the tea leaves were measured under different airflow velocities. When the measurements of two clips of the 9140 probe clamped the same side of the samples and were kept away from the main veins without injury to the samples. The two clips were kept parallel with the spacing of 20 mm. The clamping is shown in Figure 2.



Figure 2 Leaf clamping by the test probe

The excitation voltage and frequency were set to 1.0 V and 3.0 kHz, respectively. The temperature and humidity recorder was placed in the incubator to collect

air temperature and humidity around the samples. The collection interval of the recorder and the LCR tester was 1.0 s.

## 3 Results and analysis

### 3.1 Responses of resistance, reactance and impedance to low-temperature stress

The resistance response to low-temperature stress under air humidity below 70% is shown in Figure 3. The resistance increased with the decrease of the temperature. The resistance began to increase slowly when air temperature decreased from  $8.0^\circ\text{C}$  to around  $-6.3^\circ\text{C}$ , and then increased rapidly from around  $-6.3^\circ\text{C}$  to  $-15.0^\circ\text{C}$ . The resistance measured at airflow velocity of 2.5 m/s was larger than that measured at other airflow velocities within the whole range of temperatures.

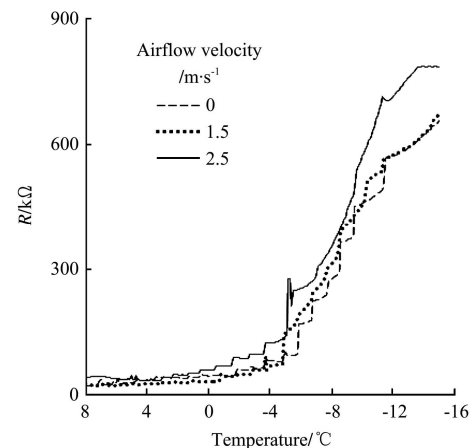

Figure 3 Resistance response to low-temperature stress under air humidity below 70%

The reactance response to low-temperature stress under air humidity below 70% is shown in Figure 4. The reactance kept steady when air temperature decreased from  $8.0^\circ\text{C}$  to around  $-6.3^\circ\text{C}$ , but there was a transient drop at the temperature around  $-6.3^\circ\text{C}$ , and then increased rapidly from around  $-6.3^\circ\text{C}$  to  $-15^\circ\text{C}$ . The reactance measured at airflow velocity of 1.5 m/s was larger than that measured at other airflow velocities at temperatures after the drop.

The impedance response to low-temperature stress under air humidity below 70% was similar to the resistance and reactance response. As shown in Figure 5, the impedance increased with the decrease of the temperature and it rose sharply with the temperature from around  $-6.3^\circ\text{C}$  to  $-15^\circ\text{C}$ . The impedance measured at airflow velocity of 0 m/s was less than that measured at

other airflow velocities at temperatures below around  $-6.3^{\circ}\text{C}$ .

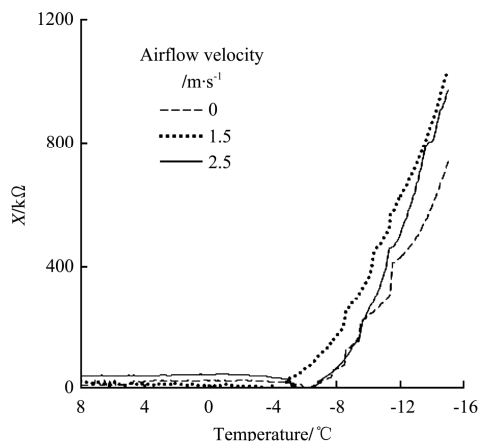

Figure 4 Reactance response to low-temperature stress under air humidity below 70%

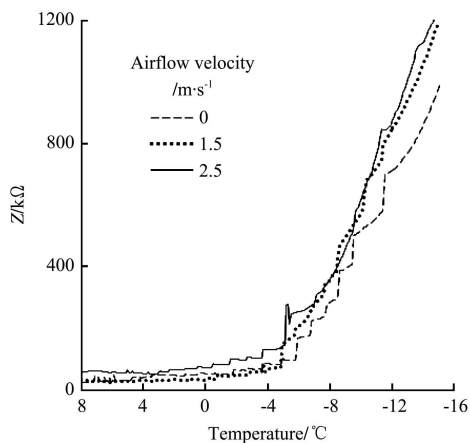

Figure 5 Impedance response to low-temperature stress under air humidity below 70%

There were no significant differences of all the parameters and variation trend under different airflow velocities. There was an exponential relationship between the impedance ( $y$ ) and the temperature ( $x$ ) and a second-order polynomial relationship between the resistance ( $y$ ) and the temperature ( $x$ ). The fitted equations are listed in Table 3.

**Table 3 Fitted equations of resistance and impedance**

Parameter	Fitted equation	Determination coefficient
Resistance	$y = 2.226x^2 - 11.459x + 30.737$	0.9823
Impedance	$y = 23.823e^{0.0184x}$	0.9863

At humidity of 70%–90% and above 90%, the results were similar to the above.

### 3.2 Response of capacitance to low-temperature stress

Figures 6-8 show the capacitance responses to low-temperature stress under different airflow velocities

at humidity below 70%, 70% to 79% and above 90%, respectively. The capacitance was rather small and almost no change occurred with almost all air temperatures under different air velocity and humidity conditions, but the responses had obvious characteristics of a few abrupt peaks. The maximum peak capacitance was representative of its response at certain humidity and airflow velocity. The peak and its corresponding temperature were the typical ones.

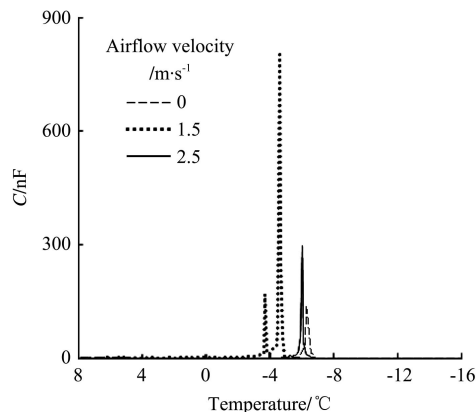

Figure 6 Capacitance response to low-temperature stress under air humidity below 70%

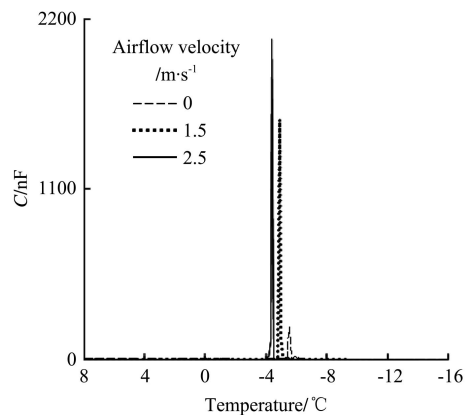

Figure 7 Capacitance response to low-temperature stress under air humidity between 70% and 90%

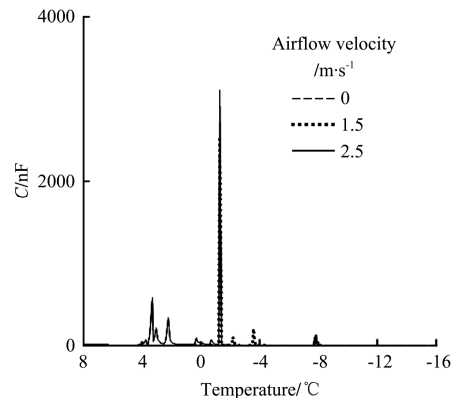

Figure 8 Capacitance response to low-temperature stress under air humidity above 90%

The maximum peak capacitance and its typical temperature for all the treatments were listed in Table 4. Under all the treatments of humidity, the typical temperature was the lowest when airflow velocity was 0 m/s. At humidity above 70% the typical temperature decreased with airflow velocity. And the typical temperature increased with humidity at airflow velocity of 2.5 m/s. The typical temperature was  $-7.8^{\circ}\text{C}$  at the humidity above 90% and the velocity of 0 m/s, and was  $-1.3^{\circ}\text{C}$  at the humidity above 90% and the velocity of 2.5 m/s.

**Table 4 Maximum peak capacitance and its typical temperature**

Air humidity/%	Airflow velocity/ $\text{m}\cdot\text{s}^{-1}$	Capacitance/nF	Temperature/ $^{\circ}\text{C}$
below 70	0	143.03	-6.3
below 70	1.5	802.83	-4.6
below 70	2.5	297.05	-6.0
70-90	0	208.84	-5.6
70-90	1.5	1 552.10	-4.9
70-90	2.5	2 071.70	-4.4
above 90	0	155.16	-7.8
above 90	1.5	2 537.80	-1.3
above 90	2.5	3 110.30	-1.3

At humidity below 70% and airflow velocity of 0 m/s the capacitance reached its maximum peak and its typical temperature was  $-6.3^{\circ}\text{C}$ , around which the resistance, reactance and impedance also had obvious characteristics of variation. Thus, there may be some relationship between typical temperature and critical temperature.

The cellular membrane system of a tea leaf is capacitive<sup>[19,20]</sup> and the equivalent capacitance of the leaf should be described as Equation (1):

$$C=\varepsilon S/d \quad (1)$$

where,  $\varepsilon$  is the permittivity, F/m;  $S$  is leaf area,  $\text{m}^2$ ;  $d$  is leaf thickness, m.

With certain leaf area and thickness the capacitance changes only with  $\varepsilon$ . Under low-temperature stress, the membranes are first injured with cytosol loss and chemical bond fracture<sup>[21-24]</sup> because of the phase transition of the cellular membrane system, which develops from the states of liquid crystal to gel, and then to solidification. During the gel state the permittivity is extremely large, so the capacitance has the abrupt peaks perhaps because the gel state lasts extremely short time.

Therefore, the typical temperature could indicate critical temperature of tea leaves for frost protection control.

## 4 Conclusions

As one of the most important control factors for frost protection, critical temperature of crops is difficult to be quantified, but still could be indicated by some characteristics of crops' electrical property. With tea leaves exposed to low-temperature stress under different humidities and airflow velocities, the characteristics of their capacitance, impedance, resistance and reactance under were found with a testing system.

1) The impedance and resistance first increased slowly, and the reactance kept steady above a certain temperature, and then they all increased rapidly. There were no significant differences of the above parameters and variation trend under different airflow velocities and humidities.

2) A few abrupt peaks occurred to the capacitance response at different air velocities and humidities, corresponding to certain typical temperatures. The maximum peak capacitance was representative of its response. The typical temperatures were close to a range where the other three parameters began to increase rapidly, which might be relevant to critical temperature.

Therefore, the capacitance could be used as a testing parameter due to its characteristic response to low-temperature stress, and typical temperature could indicate critical temperature of tea leaves for frost protection control. The future study will focus on the validation of the quantitative relationship between typical temperature and critical temperature through correlating the characteristics of tea leaf capacitance and physiological process.

## Acknowledgements

The authors are grateful to the financial support by National High Technology Research and Development Program of China (2012AA10A508), National Natural Science Foundation of China (31101089) and Priority Academic Program Development of Jiangsu Higher Education Institutions (2014-37).

## [References]

- [1] Yang Y J. China tea cultivation. Shanghai: Shanghai Scientific and Technical Publishers, 2005.
- [2] Wang F, Zhang Y Q. The influence of late spring coldness on famous tea production and its prevention. *Agriculture Equipment & Technology*, 2004; 30(6): 26. doi: 10.3969/j.issn.1671-6337.2004.06.019. (in Chinese with English abstract)
- [3] Hu Y G, Li P P, Dai Q L, Zhang X L, Tanaka K H, Cui G L. System design and experiment on elevated wind machine for tea frost protection. *Transactions of the CSAM*, 2007; 38(12): 97–99, 124. doi: 10.3969/j.issn.1000-1298.2007.12.024. (in Chinese with English abstract)
- [4] Hu Y G, Zhu X L, Zhao M L, Snyder R L, Li P P. Operation effects of wind machines for frost protection of tea trees on different time scales. *Transactions of the CSAM*, 2013; 44(12): 252–257. doi: 10.6041/j.issn.1000-1298.2013.12.042. (in Chinese with English abstract)
- [5] Ghaemi A A, Rafiee M R, Sepaskhah A R. Tree-temperature monitoring for frost protection of orchards in semi-arid regions using sprinkler irrigation. *Agricultural Sciences in China*, 2009; 8(1): 98–107. doi: 10.1016/S1671-2927(09)60014-6.
- [6] Ribeiro A C, De Melo-Abreu J P, Snyder R L. Apple orchard frost protection with wind machine operation. *Agricultural Forest Meteorology*, 2006; 141(2-4): 71–81. doi: 10.1016/j.agrformet.2006.08.019.
- [7] Snyder R L, De Melo-Abreu J P. Frost protection: fundamentals, practice and economics-Volume I. Rome: Food and Agriculture Organization of the United Nations, 2005.
- [8] Hu Y G. Mechanism and control technology of late frost protection for tea plant (*Camellia sinensis* L.) through air disturbance. PhD dissertation. Zhenjiang: Jiangsu University, 2011. (in Chinese)
- [9] Levitt J. Responses of plants to environmental stress (Volume II) – Water, radiation, salt, and other stresses. New York: Academic Press Inc. 1980.
- [10] Mills L J, Ferguson J C, Keller M. Cold-hardiness evaluation of grapevine buds and cane tissues. *American Journal of Enology and Viticulture*, 2006; 57(2): 194–200.
- [11] Yang H, Tang Q, Luo X P. Measurement of cold resistance of *Camellia sinensis* based on electrical conductivity method combining with logistic equation. *Tea in Fujian*, 2006; (3): 30–32. doi: 10.3969/j.issn.1005-2291.2006.03.017. (in Chinese with Chinese abstract)
- [12] Meng Q R, Xu X Y, Yang J M, Liang Y Q, Zhu Z H, Li Y H, et al. Preliminary study on cold resistance of floral organs of apricot. *Journal of Agricultural University of Hebei*, 2006; 29(3): 22–25. doi: 10.3969/j.issn.1000-1573.2006.03.006. (in Chinese with English abstract)
- [13] Robert O B, Jonathan K C. Electrical resistance measurements to detect Dutch elm disease prior to symptom expression. *Canadian Journal of Forestry Research*, 1980; 10(1): 111–114. doi: 10.1139/cjfr-2014-0380.
- [14] Zhang S F, Jin S D, Chen Y. Study on physiological resistance information about corn water deficiency in water-saving irrigation. *Journal of Jiangsu University of Science and Technology*, 1996; 17(6): 6–10. (in Chinese with English abstract)
- [15] Guo W C, Wu L, Wei Y S. Influence of water loss on physiological and electrical properties of plants. *Journal of Northwest A&F University (Natural Science Edition)*, 2007; 35(4): 185–191. doi: 10.3321/j.issn:1671-9387.2007.04.040. (in Chinese with English abstract)
- [16] Krol E, Dziubinska H, Trebacz K. Low-temperature induced transmembrane potential changes in the liverwort *Conocephalum conicum*. *Plant and Cell Physiology*, 2003; 44(5): 527–533. doi: 10.1093/pcp/pcg070.
- [17] Zhang H W, Chen H J, Di B, Zhang J J. Relationship between electrical impedance spectroscopy parameters and frost hardiness in peach shoot during cold hardening. *Journal of Agricultural University of Hebei*, 2014; 37(2): 45–57. (in Chinese with English abstract) doi: 10.13320/j.cnki.jauh.2014.0035.
- [18] Sun Y Y, Yu D Y. Agricultural biological mechanics and agricultural biological electromagnetism. China Agriculture Press. 1996.
- [19] Smith J R. The tonoplast impedance of *Chara*. *Journal of Experimental Botany*, 1983; 34(139): 120–129. doi: 10.1093/jxb/34.2.120.
- [20] Zhang M, Willison J H M. Electrical impedance analysis in plant tissues: the effect of freeze-thaw injury on the electrical properties of potato tuber and carrot root tissues. *Canadian Journal of Plant Science*, 1992; 72(2): 545–553. doi: 10.4141/cjps92-068.
- [21] Leborgne N, Dupou-Cézanne L, Teulières C, Canut H, Tocanne J F, Boudet A M. Lateral and rotational mobilities of lipids in specific cellular membranes of *Eucalyptus gunnii* cultivars exhibiting different freezing tolerance. *Plant Physiology*, 1992; 100(1): 246–254.
- [22] Steponkus P L, Lynch D V, Uemura M. The influence of cold acclimation on the lipid composition and cryobehaviour of the plasma membrane of isolated rye protoplasts. *Philosophical Transactions of the Royal Society of London. Series B—Biological Sciences*, 1990; 326(1237): 571–583. doi: 10.1098/rstb.1990.0032.
- [23] Örvär B L, Sangwan V, Omann F, Dhindsa R S. Early steps in cold sensing by plant cells: The role of actin cytoskeleton and membrane fluidity. *The Plant Journal*, 2000; 23(6): 785–794. doi: 10.1046/j.1365-313x.2000.00845.x.
- [24] Guy C. Cold acclimation and freezing stress tolerance: role of protein metabolism. *Annual Review of Plant Physiology and Plant Molecular Biology*, 1990; 41(1): 187–223. doi: 10.1146/annurev.pp.41.060190.001155.